

Nybro 5 Dimming Type

Surface Down light luminaires

Project :	Location :	Type :	Quantity :
Note :			

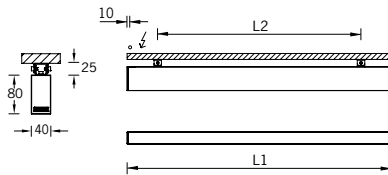
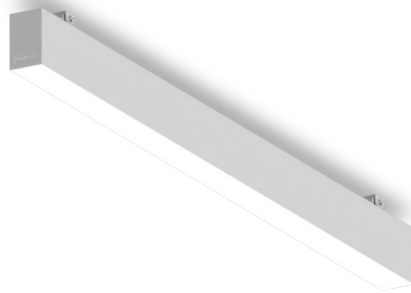

Luminaire Structure

Pendant, surface and suspended interior lighting system Powerful, flexible continuous illumination with a myriad of light source and control options

Light Symbol



Down light

Ordering guide sample

<p>NYB-80401 - O - W30 - DA - A81881</p> <p>Diffuser Colour Dim Type Accessory</p>	<p>Diffuser for light output control O – Opal diffuser UGR <19 P – Micro-prismatic UGR <13</p>	<p>Dimming Type ND – Non dimmable DI – 1-10V dimmable DA – DALI dimmable</p>	<p>Colour Temperature W27 – Warm 2700K W30 – Warm white 3000K W40 – Neutral white 4000K W50 – Cool white 5000K</p>
---	---	--	---

Product Code

Model No.	No. LED		System Power W	Lumen lm	Colour	EEC	Dimension		Weight kg
	Up	Down					L1	L2	

SURFACE CEILING MOUNTED · DOWN LIGHT · 40x80MM. · DIMMING TYPE · OPAL DIFFUSER

NYB-80401 - O - W27	-	72 LED	11	824	2700K	A++	602	396	1.69
NYB-80401 - O - W30	-	72 LED	11	862	3000K	A++	602	396	1.69
NYB-80401 - O - W40	-	72 LED	11	900	4000K	A++	602	396	1.69
NYB-80401 - O - W50	-	72 LED	11	937	5000K	A++	602	396	1.69
NYB-80402 - O - W27	-	72 LED	14	1095	2700K	A++	602	396	1.69
NYB-80402 - O - W30	-	72 LED	14	1145	3000K	A++	602	396	1.69
NYB-80402 - O - W40	-	72 LED	14	1195	4000K	A++	602	396	1.69
NYB-80402 - O - W50	-	72 LED	14	1245	5000K	A++	602	396	1.69
NYB-80411 - O - W27	-	108 LED	15	1237	2700K	A++	890	684	2.20
NYB-80411 - O - W30	-	108 LED	15	1293	3000K	A++	890	684	2.20
NYB-80411 - O - W40	-	108 LED	15	1350	4000K	A++	890	684	2.20
NYB-80411 - O - W50	-	108 LED	15	1406	5000K	A++	890	684	2.20
NYB-80412 - O - W27	-	108 LED	19	1642	2700K	A++	890	684	2.20
NYB-80412 - O - W30	-	108 LED	19	1718	3000K	A++	890	684	2.20
NYB-80412 - O - W40	-	108 LED	19	1793	4000K	A++	890	684	2.20
NYB-80412 - O - W50	-	108 LED	19	1868	5000K	A++	890	684	2.20

Optional diffuser



(- O) Opal diffuser UGR <19

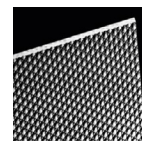

(-P) Micro-prismatic diffuser UGR <13

Dimming Type

ND DI DA

Colour Code

- 01	- 03	- 05
Black RAL 9011	White RAL 9003	Matt Silver RAL 9006

RESET

HEADQUARTERS EUROPE

Ligman Europe s.r.o.
VGP Park Usti nad Labem, P2 | Přestanov 120 | 40317 Přestanov |
Czech Republic | Tel. +420 477 07 1500 | sales.cz@ligman.com
www.ligman.com

HEADQUARTERS THAILAND

Ligman Lighting Co., Ltd.
17/2 | Moo 4 | Monthong | Bangnampreaw | Chachoengsao 24150 |
Thailand | Tel : +66 (2) 7339140 | info@ligman.com

Ligman Ltd.
Victory Way | Crossways | Dartford DA2 6QD |
United Kingdom | Tel +66 2 733 9140 | Fax +66 2 733 9153 |
sales.uk@ligman.com

Technical amendments reserved.

Nybro 5 Dimming Type

Surface Down light luminaires

Project :	Location :	Type :	Quantity :
Note :			

Product Code

Model No.	No. LED		System Power W	Lumen lm	Colour	EEC	Dimension		Weight kg
	Up	Down					L1	L2	
SURFACE CEILING MOUNTED · DOWN LIGHT · 40x80MM · DIMMING TYPE · OPAL DIFFUSER									
NYB-80421 - O - W27	-	144 LED	19	1649	2700K	A++	1178	972	2.72
NYB-80421 - O - W30	-	144 LED	19	1724	3000K	A++	1178	972	2.72
NYB-80421 - O - W40	-	144 LED	19	1800	4000K	A++	1178	972	2.72
NYB-80421 - O - W50	-	144 LED	19	1875	5000K	A++	1178	972	2.72
NYB-80422 - O - W27	-	144 LED	25	2189	2700K	A++	1178	972	2.72
NYB-80422 - O - W30	-	144 LED	25	2290	3000K	A++	1178	972	2.72
NYB-80422 - O - W40	-	144 LED	25	2390	4000K	A++	1178	972	2.72
NYB-80422 - O - W50	-	144 LED	25	2489	5000K	A++	1178	972	2.72
NYB-80431 - O - W27	-	180 LED	24	2061	2700K	A++	1466	1260	3.24
NYB-80431 - O - W30	-	180 LED	24	2156	3000K	A++	1466	1260	3.24
NYB-80431 - O - W40	-	180 LED	24	2250	4000K	A++	1466	1260	3.24
NYB-80431 - O - W50	-	180 LED	24	2344	5000K	A++	1466	1260	3.24
NYB-80432 - O - W27	-	180 LED	32	2737	2700K	A++	1466	1260	3.24
NYB-80432 - O - W30	-	180 LED	32	2863	3000K	A++	1466	1260	3.24
NYB-80432 - O - W40	-	180 LED	32	2988	4000K	A++	1466	1260	3.24
NYB-80432 - O - W50	-	180 LED	32	3112	5000K	A++	1466	1260	3.24
NYB-80441 - O - W27	-	216 LED	28	2473	2700K	A++	1754	1548	3.57
NYB-80441 - O - W30	-	216 LED	28	2587	3000K	A++	1754	1548	3.57
NYB-80441 - O - W40	-	216 LED	28	2700	4000K	A++	1754	1548	3.57
NYB-80441 - O - W50	-	216 LED	28	2812	5000K	A++	1754	1548	3.57
NYB-80442 - O - W27	-	216 LED	38	3284	2700K	A++	1754	1548	3.57
NYB-80442 - O - W30	-	216 LED	38	3434	3000K	A++	1754	1548	3.57
NYB-80442 - O - W40	-	216 LED	38	3585	4000K	A++	1754	1548	3.57
NYB-80442 - O - W50	-	216 LED	38	3734	5000K	A++	1754	1548	3.57
NYB-80451 - O - W27	-	288 LED	37	3298	2700K	A++	2330	2124	4.80
NYB-80451 - O - W30	-	288 LED	37	3449	3000K	A++	2330	2124	4.80
NYB-80451 - O - W40	-	288 LED	37	3600	4000K	A++	2330	2124	4.80
NYB-80451 - O - W50	-	288 LED	37	3750	5000K	A++	2330	2124	4.80
NYB-80452 - O - W27	-	288 LED	50	4378	2700K	A++	2330	2124	4.80
NYB-80452 - O - W30	-	288 LED	50	4579	3000K	A++	2330	2124	4.80
NYB-80452 - O - W40	-	288 LED	50	4780	4000K	A++	2330	2124	4.80
NYB-80452 - O - W50	-	288 LED	50	4979	5000K	A++	2330	2124	4.80
NYB-80461 - O - W27	-	360 LED	46	4122	2700K	A++	2906	2700	5.86
NYB-80461 - O - W30	-	360 LED	46	4311	3000K	A++	2906	2700	5.86
NYB-80461 - O - W40	-	360 LED	46	4500	4000K	A++	2906	2700	5.86
NYB-80461 - O - W50	-	360 LED	46	4687	5000K	A++	2906	2700	5.86
NYB-80462 - O - W27	-	360 LED	62	5473	2700K	A++	2906	2700	5.86
NYB-80462 - O - W30	-	360 LED	62	5724	3000K	A++	2906	2700	5.86
NYB-80462 - O - W40	-	360 LED	62	5975	4000K	A++	2906	2700	5.86
NYB-80462 - O - W50	-	360 LED	62	6224	5000K	A++	2906	2700	5.86

Accessory

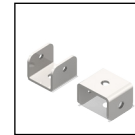

Bracket For Ceilings (A81281)



Continuous coupler bracket (A81881)

* Installation manual available online at www.ligman.com.

* Luminous flux and system power are rated from absolute photometry according to LM-79-08 standard for LED luminaire.
* Photometric diagram for standard non-accessory, please consult the factory in case accessory option.

HEADQUARTERS EUROPE

Ligman Europe s.r.o.
VGP Park Ústí nad Labem, P2 | Přestanov 120 | 40317 Přestanov |
Czech Republic | Tel. +420 477 07 1500 | sales.cz@ligman.com
www.ligman.com

HEADQUARTERS THAILAND

Ligman Lighting Co., Ltd.
17/2 | Moo 4 | Monthong | Bangnampreaw | Chachoengsao 24150 |
Thailand | Tel. +66 (2) 7339140 | info@ligman.com

Ligman Ltd.
Victory Way | Crossways | Dartford DA2 6QD |
United Kingdom | Tel +66 2 733 9140 | Fax +66 2 733 9153 |
sales.uk@ligman.com

Technical amendments reserved.

Nybro 5 Dimming Type

Surface Down light luminaires

Project :	Location :	Type :	Quantity :
Note :			

Model No.	No. LED		System Power W	Lumen lm	Colour	EEC	Dimension		Weight kg
	Up	Down					L1	L2	

SURFACE CEILING MOUNTED · DOWN LIGHT · 40x80MM · DIMMING TYPE · MICRO-PRISMATIC DIFFUSER

NYB-80401 - P - W27	-	72 LED	11	703	2700K	A++	602	396	1.69
NYB-80401 - P - W30	-	72 LED	11	735	3000K	A++	602	396	1.69
NYB-80401 - P - W40	-	72 LED	11	767	4000K	A++	602	396	1.69
NYB-80401 - P - W50	-	72 LED	11	799	5000K	A++	602	396	1.69
NYB-80402 - P - W27	-	72 LED	14	934	2700K	A++	602	396	1.69
NYB-80402 - P - W30	-	72 LED	14	977	3000K	A++	602	396	1.69
NYB-80402 - P - W40	-	72 LED	14	1020	4000K	A++	602	396	1.69
NYB-80402 - P - W50	-	72 LED	14	1062	5000K	A++	602	396	1.69
NYB-80411 - P - W27	-	108 LED	15	1054	2700K	A++	890	684	2.20
NYB-80411 - P - W30	-	108 LED	15	1103	3000K	A++	890	684	2.20
NYB-80411 - P - W40	-	108 LED	15	1151	4000K	A++	890	684	2.20
NYB-80411 - P - W50	-	108 LED	15	1199	5000K	A++	890	684	2.20
NYB-80412 - P - W27	-	108 LED	19	1402	2700K	A++	890	684	2.20
NYB-80412 - P - W30	-	108 LED	19	1467	3000K	A++	890	684	2.20
NYB-80412 - P - W40	-	108 LED	19	1531	4000K	A++	890	684	2.20
NYB-80412 - P - W50	-	108 LED	19	1595	5000K	A++	890	684	2.20
NYB-80421 - P - W27	-	144 LED	19	1406	2700K	A++	1178	972	2.72
NYB-80421 - P - W30	-	144 LED	19	1471	3000K	A++	1178	972	2.72
NYB-80421 - P - W40	-	144 LED	19	1535	4000K	A++	1178	972	2.72
NYB-80421 - P - W50	-	144 LED	19	1599	5000K	A++	1178	972	2.72
NYB-80422 - P - W27	-	144 LED	25	1870	2700K	A++	1178	972	2.72
NYB-80422 - P - W30	-	144 LED	25	1955	3000K	A++	1178	972	2.72
NYB-80422 - P - W40	-	144 LED	25	2041	4000K	A++	1178	972	2.72
NYB-80422 - P - W50	-	144 LED	25	2126	5000K	A++	1178	972	2.72
NYB-80431 - P - W27	-	180 LED	24	1757	2700K	A++	1466	1260	2.72
NYB-80431 - P - W30	-	180 LED	24	1837	3000K	A++	1466	1260	2.72
NYB-80431 - P - W40	-	180 LED	24	1918	4000K	A++	1466	1260	2.72
NYB-80431 - P - W50	-	180 LED	24	1998	5000K	A++	1466	1260	2.72
NYB-80432 - P - W27	-	180 LED	32	2337	2700K	A++	1466	1260	2.72
NYB-80432 - P - W30	-	180 LED	32	2444	3000K	A++	1466	1260	2.72
NYB-80432 - P - W40	-	180 LED	32	2551	4000K	A++	1466	1260	2.72
NYB-80432 - P - W50	-	180 LED	32	2657	5000K	A++	1466	1260	2.72
NYB-80441 - P - W27	-	216 LED	28	2109	2700K	A++	1754	1548	3.24
NYB-80441 - P - W30	-	216 LED	28	2205	3000K	A++	1754	1548	3.24
NYB-80441 - P - W40	-	216 LED	28	2302	4000K	A++	1754	1548	3.24
NYB-80441 - P - W50	-	216 LED	28	2398	5000K	A++	1754	1548	3.24
NYB-80442 - P - W27	-	216 LED	38	2804	2700K	A++	1754	1548	3.24
NYB-80442 - P - W30	-	216 LED	38	2932	3000K	A++	1754	1548	3.24
NYB-80442 - P - W40	-	216 LED	38	3061	4000K	A++	1754	1548	3.24
NYB-80442 - P - W50	-	216 LED	38	3188	5000K	A++	1754	1548	3.24
NYB-80451 - P - W27	-	288 LED	37	2811	2700K	A++	2330	2124	4.80
NYB-80451 - P - W30	-	288 LED	37	2940	3000K	A++	2330	2124	4.80
NYB-80451 - P - W40	-	288 LED	37	3069	4000K	A++	2330	2124	4.80
NYB-80451 - P - W50	-	288 LED	37	3197	5000K	A++	2330	2124	4.80
NYB-80452 - P - W27	-	288 LED	50	3739	2700K	A++	2330	2124	4.80
NYB-80452 - P - W30	-	288 LED	50	3911	3000K	A++	2330	2124	4.80
NYB-80452 - P - W40	-	288 LED	50	4082	4000K	A++	2330	2124	4.80
NYB-80452 - P - W50	-	288 LED	50	4252	5000K	A++	2330	2124	4.80
NYB-80461 - P - W27	-	360 LED	46	3515	2700K	A++	2906	2700	5.86
NYB-80461 - P - W30	-	360 LED	46	3676	3000K	A++	2906	2700	5.86
NYB-80461 - P - W40	-	360 LED	46	3837	4000K	A++	2906	2700	5.86
NYB-80461 - P - W50	-	360 LED	46	3997	5000K	A++	2906	2700	5.86
NYB-80462 - P - W27	-	360 LED	62	4673	2700K	A++	2906	2700	5.86
NYB-80462 - P - W30	-	360 LED	62	4888	3000K	A++	2906	2700	5.86
NYB-80462 - P - W40	-	360 LED	62	5102	4000K	A++	2906	2700	5.86
NYB-80462 - P - W50	-	360 LED	62	5314	5000K	A++	2906	2700	5.86

Photometric

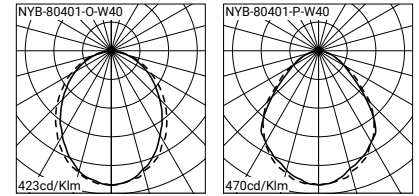

HEADQUARTERS EUROPE

Ligman Europe s.r.o.
VGP Park Usti nad Labem, P2 | Přestanov 120 | 40317 Přestanov |
Czech Republic | Tel. +420 477 07 1500 | sales.cz@ligman.com
www.ligman.com

HEADQUARTERS THAILAND

Ligman Lighting Co., Ltd.
17/2 | Moo 4 | Monthong | Bangnampreaw | Chachoengsao 24150 |
Thailand | Tel. +66 (2) 7339140 | info@ligman.com

Ligman Ltd.
Victory Way | Crossways | Dartford DA2 6QD |
United Kingdom | Tel. +66 2 733 9140 | Fax +66 2 733 9153 |
sales.uk@ligman.com

Technical amendments reserved.

Nybro 5 Sensor Control

Surface ceiling Down light

Project :	Location :	Type :	Quantity :
Note :			

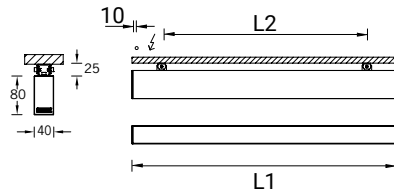
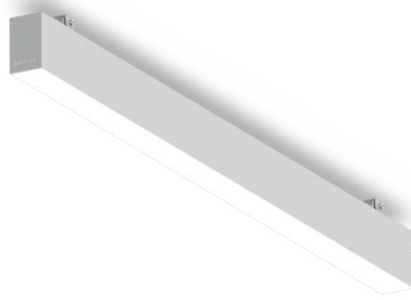
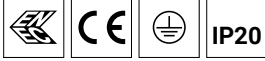

Luminaire Structure

Pendant, surface and suspended interior lighting system Powerful, flexible continuous illumination with a myriad of light source and control options

Light Symbol



Down light

Ordering guide sample

NYB-80423	- O -	W30 -	WBT -	A81581	Diffuser for light output control	Colour Temperature
	Diffuser	Colour	Sensor	Accessory	O - Opal diffuser UGR <19	W27 - Warm 2700K
					P - Micro-prismatic UGR <13	W30 - Warm white 3000K
						W40 - Neutral white 4000K
						W50 - Cool white 5000K

Optional diffuser

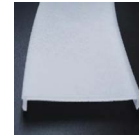

(- O)
Opal diffuser
UGR <19

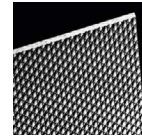

(- P)
Micro-prismatic diffuser
UGR <13

Product Code

Model No.	No. LED		System Power W	Lumen lm	Colour	EEC	Dimension		Weight kg
	Up	Down					L1	L2	

SURFACE CEILING MOUNTED · DOWN LIGHT · 40x80MM · SENSOR CONTROL · OPAL DIFFUSER

NYB-80423	- O -	W27	-	132 LED	23	2006	2700K	A++	1178	922	2.97
NYB-80423	- O -	W30	-	132 LED	23	2098	3000K	A++	1178	922	2.97
NYB-80423	- O -	W40	-	132 LED	23	2190	4000K	A++	1178	922	2.97
NYB-80423	- O -	W50	-	132 LED	23	2281	5000K	A++	1178	922	2.97
NYB-80433	- O -	W27	-	168 LED	30	2554	2700K	A++	1466	1210	3.49
NYB-80433	- O -	W30	-	168 LED	30	2671	3000K	A++	1466	1210	3.49
NYB-80433	- O -	W40	-	168 LED	30	2788	4000K	A++	1466	1210	3.49
NYB-80433	- O -	W50	-	168 LED	30	2904	5000K	A++	1466	1210	3.49
NYB-80443	- O -	W27	-	204 LED	36	3101	2700K	A++	1754	1498	4.02
NYB-80443	- O -	W30	-	204 LED	36	3243	3000K	A++	1754	1498	4.02
NYB-80443	- O -	W40	-	204 LED	36	3385	4000K	A++	1754	1498	4.02
NYB-80443	- O -	W50	-	204 LED	36	3526	5000K	A++	1754	1498	4.02
NYB-80453	- O -	W27	-	276 LED	48	4195	2700K	A++	2330	2074	5.05
NYB-80453	- O -	W30	-	276 LED	48	4388	3000K	A++	2330	2074	5.05
NYB-80453	- O -	W40	-	276 LED	48	4580	4000K	A++	2330	2074	5.05
NYB-80453	- O -	W50	-	276 LED	48	4771	5000K	A++	2330	2074	5.05
NYB-80463	- O -	W27	-	348 LED	60	5290	2700K	A++	2906	2650	6.11
NYB-80463	- O -	W30	-	348 LED	60	5532	3000K	A++	2906	2650	6.11
NYB-80463	- O -	W40	-	348 LED	60	5775	4000K	A++	2906	2650	6.11
NYB-80463	- O -	W50	-	348 LED	60	6015	5000K	A++	2906	2650	6.11

Accessory

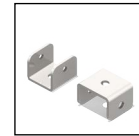

Bracket For
Ceilings
(A81281)



Continuous coupler
bracket
(A81881)

Colour Code

- 01	- 03	- 05	RESET
Black RAL 9011	White RAL 9003	Matt Silver RAL 9006	

HEADQUARTERS EUROPE

Ligman Europe s.r.o.
VGP Park Usti nad Labem, P2 | Přestanov 120 | 40317 Přestanov |
Czech Republic | Tel. +420 477 07 1500 | sales.cz@ligman.com
www.ligman.com

HEADQUARTERS THAILAND

Ligman Lighting Co., Ltd.
17/2 | Moo 4 | Monthong | Bangnampreaw | Chachoengsao 24150 |
Thailand | Tel : +66 (2) 7339140 | info@ligman.com

Ligman Ltd.
Victory Way | Crossways | Dartford DA2 6QD |
United Kingdom | Tel +66 2 733 9140 | Fax +66 2 733 9153 |
sales.uk@ligman.com

Technical amendments reserved.

Nybro 5 Sensor Control

Surface ceiling Down light

Project :	Location :	Type :	Quantity :
Note :			

Product Code

Model No.	No. LED		System Power W	Lumen lm	Colour	EEC	Dimension		Weight kg
	Up	Down					L1	L2	
SURFACE CEILING MOUNTED · DOWN LIGHT · 40x80MM. · SENSOR CONTROL · MICRO-PRISMATIC DIFFUSER									
NYB-80423 - P - W27	-	132 LED	23	1545	2700K	A++	1178	922	2.97
NYB-80423 - P - W30	-	132 LED	23	1616	3000K	A++	1178	922	2.97
NYB-80423 - P - W40	-	132 LED	23	1687	4000K	A++	1178	922	2.97
NYB-80423 - P - W50	-	132 LED	23	1757	5000K	A++	1178	922	2.97
NYB-80433 - P - W27	-	168 LED	30	2177	2700K	A++	1466	1210	3.49
NYB-80433 - P - W30	-	168 LED	30	2277	3000K	A++	1466	1210	3.49
NYB-80433 - P - W40	-	168 LED	30	2377	4000K	A++	1466	1210	3.49
NYB-80433 - P - W50	-	168 LED	30	2476	5000K	A++	1466	1210	3.49
NYB-80443 - P - W27	-	204 LED	36	2644	2700K	A++	1754	1498	4.02
NYB-80443 - P - W30	-	204 LED	36	2765	3000K	A++	1754	1498	4.02
NYB-80443 - P - W40	-	204 LED	36	2886	4000K	A++	1754	1498	4.02
NYB-80443 - P - W50	-	204 LED	36	3006	5000K	A++	1754	1498	4.02
NYB-80453 - P - W27	-	276 LED	48	3576	2700K	A++	2330	2074	5.05
NYB-80453 - P - W30	-	276 LED	48	3740	3000K	A++	2330	2074	5.05
NYB-80453 - P - W40	-	276 LED	48	3904	4000K	A++	2330	2074	5.05
NYB-80453 - P - W50	-	276 LED	48	4066	5000K	A++	2330	2074	5.05
NYB-80463 - P - W27	-	348 LED	60	5410	2700K	A++	2906	2650	6.11
NYB-80463 - P - W30	-	348 LED	60	4716	3000K	A++	2906	2650	6.11
NYB-80463 - P - W40	-	348 LED	60	4923	4000K	A++	2906	2650	6.11
NYB-80463 - P - W50	-	348 LED	60	5128	5000K	A++	2906	2650	6.11

* Installation manual available online at www.ligman.com.

* Luminous flux and system power are rated from absolute photometry according to LM-79-08 standard for LED luminaire.
* Photometric diagram for standard non-accessory, please consult the factory in case accessory option.

HEADQUARTERS EUROPE

Ligman Europe s.r.o.
VGP Park Ústí nad Labem, P2 | Přestanov 120 | 40317 Přestanov |
Czech Republic | Tel. +420 477 07 1500 | sales.cz@ligman.com
www.ligman.com

HEADQUARTERS THAILAND

Ligman Lighting Co.,Ltd.
17/2 | Moo 4 | Monthong | Bangnampreaw | Chachoengsao 24150 |
Thailand | Tel : +66 (2) 7339140 | info@ligman.com

Ligman Ltd.
Victory Way | Crossways | Dartford DA2 6QD |
United Kingdom | Tel +66 2 733 9140 | Fax +66 2 733 9153 |
sales.uk@ligman.com

Technical amendments reserved.

Nybro 5 Tunable White

Surface ceiling Down light

Project :	Location :	Type :	Quantity :
Note :			

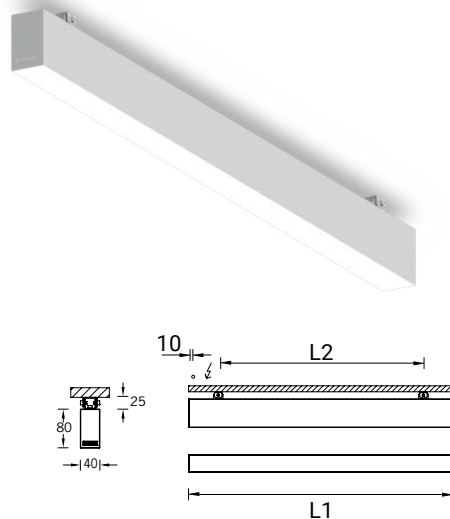

Luminaire Structure

Pendant, surface and suspended interior lighting system Powerful, flexible continuous illumination with a myriad of light source and control options

Light Symbol



Down light

Ordering guide sample

NYB-80424 - O - TUV - A81281

Diffuser Colour Accessory

Diffuser for light output control Colour Temperature
 O - Opal diffuser UGR <19 TUV - Tunable white
 P - Micro-prismatic UGR <13 2700K - 6500K

Optional diffuser

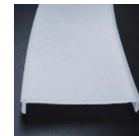

(-O)
Opal diffuser
UGR <19

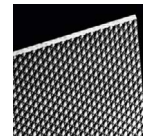

(-P)
Micro-prismatic diffuser
UGR <13

Product Code

Model No.	No. LED		System Power W	Lumen lm	Colour	EEC	Dimension		Weight kg
	Up	Down					L1	L2	
SURFACE CEILING MOUNTED · DOWN LIGHT · 40x80MM. · TUNABLE WHITE · OPAL DIFFUSER									
NYB-80424 - O - TUV	-	144 LED	24	2250	TUV	A++	1178	972	2.79
NYB-80444 - O - TUV	-	216 LED	36	3385	TUV	A++	1754	1548	4.27
NYB-80454 - O - TUV	-	288 LED	48	4780	TUV	A++	2330	2124	5.30
NYB-80464 - O - TUV	-	360 LED	60	5975	TUV	A++	2906	2700	6.36
SURFACE CEILING MOUNTED · DOWN LIGHT · 40x80MM. · TUNABLE WHITE · MICRO-PRISMATIC DIFFUSER									
NYB-80424 - P - TUV	-	144 LED	24	1918	TUV	A++	1178	972	2.79
NYB-80444 - P - TUV	-	216 LED	36	2886	TUV	A++	1754	1548	4.27
NYB-80454 - P - TUV	-	288 LED	48	4075	TUV	A++	2330	2124	5.30
NYB-80464 - P - TUV	-	360 LED	60	5094	TUV	A++	2906	2700	6.36

Wireless Bluetooth

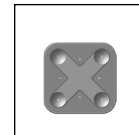

xPress Wireless switch
(A90591)



Wireless Bluetooth
(A90291)

Accessory

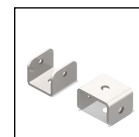

Bracket For Ceilings
(A81281)



Continuous coupler bracket
(A81881)

Colour Code

-01	-03	-05	
Black RAL 9011	White RAL 9003	Matt Silver RAL 9006	RESET

HEADQUARTERS EUROPE

Ligman Europe s.r.o.
 VGP Park Ústí nad Labem, P2 | Přestanov 120 | 40317 Přestanov |
 Czech Republic | Tel. +420 477 07 1500 | sales.cz@ligman.com
 www.ligman.com

HEADQUARTERS THAILAND

Ligman Lighting Co., Ltd.
 17/2 | Moo 4 | Monthong | Bangnampreaw | Chachoengsao 24150 |
 Thailand | Tel : +66 (2) 7339140 | info@ligman.com

Ligman Ltd.
 Victory Way | Crossways | Dartford DA2 6QD |
 United Kingdom | Tel +66 2 733 9140 | Fax +66 2 733 9153 |
 sales.uk@ligman.com

Technical amendments reserved.

Nybro 5 Dimming Type

Surface ceiling Up-Down light

Project :	Location :	Type :	Quantity :
Note :			

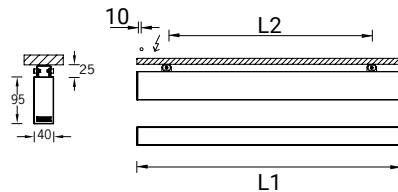
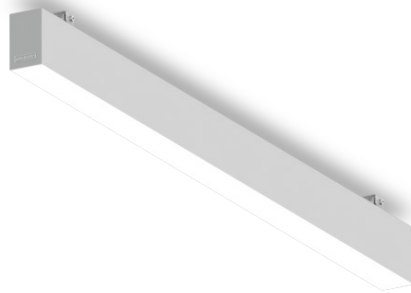

Luminaire Structure

Pendant, surface and suspended interior lighting system Powerful, flexible continuous illumination with a myriad of light source and control options

Light Symbol



Up - Down light

Ordering guide sample

NYB-80501 - O - W30 - DA - A81681

Diffuser: O - Opal diffuser UGR <19
P - Micro-prismatic UGR <13

Dimming Type: ND - Non dimmable
DI - 1-10V dimmable
DA - DALI dimmable

Colour Temperature: W27 - Warm 2700K
W30 - Warm white 3000K
W40 - Neutral white 4000K
W50 - Cool white 5000K

Product Code

Model No.	No. LED		System Power W	Lumen lm	Colour	EEC	Dimension		Weight kg
	Up	Down					L1	L2	

SURFACE CEILING MOUNTED · UP-DOWN LIGHT · 40x95MM · DIMMING TYPE · OPAL DIFFUSER

NYB-80501 - O - W27	60 LED	72 LED	21	1884	2700K	A++	602	400	2.51
NYB-80501 - O - W30	60 LED	72 LED	21	1971	3000K	A++	602	400	2.51
NYB-80501 - O - W40	60 LED	72 LED	21	2057	4000K	A++	602	400	2.51
NYB-80501 - O - W50	60 LED	72 LED	21	2143	5000K	A++	602	400	2.51
NYB-80502 - O - W27	60 LED	72 LED	28	2505	2700K	A++	602	400	2.51
NYB-80502 - O - W30	60 LED	72 LED	28	2620	3000K	A++	602	400	2.51
NYB-80502 - O - W40	60 LED	72 LED	28	2735	4000K	A++	602	400	2.51
NYB-80502 - O - W50	60 LED	72 LED	28	2849	5000K	A++	602	400	2.51
NYB-80511 - O - W27	96 LED	108 LED	29	2826	2700K	A++	890	700	3.15
NYB-80511 - O - W30	96 LED	108 LED	29	2955	3000K	A++	890	700	3.15
NYB-80511 - O - W40	96 LED	108 LED	29	3085	4000K	A++	890	700	3.15
NYB-80511 - O - W50	96 LED	108 LED	29	3213	5000K	A++	890	700	3.15
NYB-80512 - O - W27	96 LED	108 LED	39	3757	2700K	A++	890	700	3.15
NYB-80512 - O - W30	96 LED	108 LED	39	3930	3000K	A++	890	700	3.15
NYB-80512 - O - W40	96 LED	108 LED	39	4102	4000K	A++	890	700	3.15
NYB-80512 - O - W50	96 LED	108 LED	39	4273	5000K	A++	890	700	3.15

Optional diffuser

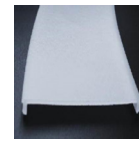

(- O)
Opal diffuser
UGR <19

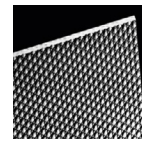

(-P)
Micro-prismatic diffuser
UGR <13

Dimming Type

ND DI DA

HEADQUARTERS EUROPE

Ligman Europe s.r.o.
VGP Park Usti nad Labem, P2 | Přestanov 120 | 40317 Přestanov |
Czech Republic | Tel. +420 477 07 1500 | sales.cz@ligman.com
www.ligman.com

HEADQUARTERS THAILAND

Ligman Lighting Co., Ltd.
17/2 | Moo 4 | Monthong | Bangnampreaw | Chachoengsao 24150 |
Thailand | Tel : +66 (2) 7339140 | info@ligman.com

Ligman Ltd.
Victory Way | Crossways | Dartford DA2 6QD |
United Kingdom | Tel +66 2 733 9140 | Fax +66 2 733 9153 |
sales.uk@ligman.com

Technical amendments reserved.

Nybro 5 Dimming Type

Surface ceiling Up-Down light

Project :	Location :	Type :	Quantity :
Note :			

Product Code

Model No.	No. LED		System Power W	Lumen lm	Colour	EEC	Dimension		Weight kg
	Up	Down					L1	L2	

SURFACE CEILING MOUNTED · UP-DOWN LIGHT · 40x95MM. · DIMMING TYPE · OPAL DIFFUSER

NYB-80521 - 0 - W27	132 LED	144 LED	39	3768	2700K	A++	1178	982	3.73
NYB-80521 - 0 - W30	132 LED	144 LED	39	3940	3000K	A++	1178	982	3.73
NYB-80521 - 0 - W40	132 LED	144 LED	39	4113	4000K	A++	1178	982	3.73
NYB-80521 - 0 - W50	132 LED	144 LED	39	4284	5000K	A++	1178	982	3.73
NYB-80522 - 0 - W27	132 LED	144 LED	50	5011	2700K	A++	1178	982	3.73
NYB-80522 - 0 - W30	132 LED	144 LED	50	5240	3000K	A++	1178	982	3.73
NYB-80522 - 0 - W40	132 LED	144 LED	50	5470	4000K	A++	1178	982	3.73
NYB-80522 - 0 - W50	132 LED	144 LED	50	5698	5000K	A++	1178	982	3.73
NYB-80531 - 0 - W27	168 LED	180 LED	47	4710	2700K	A++	1466	1265	4.42
NYB-80531 - 0 - W30	168 LED	180 LED	47	4926	3000K	A++	1466	1265	4.42
NYB-80531 - 0 - W40	168 LED	180 LED	47	5142	4000K	A++	1466	1265	4.42
NYB-80531 - 0 - W50	168 LED	180 LED	47	5356	5000K	A++	1466	1265	4.42
NYB-80532 - 0 - W27	168 LED	180 LED	63	6263	2700K	A++	1466	1265	4.42
NYB-80532 - 0 - W30	168 LED	180 LED	63	6550	3000K	A++	1466	1265	4.42
NYB-80532 - 0 - W40	168 LED	180 LED	63	6837	4000K	A++	1466	1265	4.42
NYB-80532 - 0 - W50	168 LED	180 LED	63	7121	5000K	A++	1466	1265	4.42
NYB-80541 - 0 - W27	204 LED	216 LED	56	5652	2700K	A++	1754	1555	5.05
NYB-80541 - 0 - W30	204 LED	216 LED	56	5911	3000K	A++	1754	1555	5.05
NYB-80541 - 0 - W40	204 LED	216 LED	56	6170	4000K	A++	1754	1555	5.05
NYB-80541 - 0 - W50	204 LED	216 LED	56	6427	5000K	A++	1754	1555	5.05
NYB-80542 - 0 - W27	204 LED	216 LED	75	7515	2700K	A++	1754	1555	5.05
NYB-80542 - 0 - W30	204 LED	216 LED	75	7859	3000K	A++	1754	1555	5.05
NYB-80542 - 0 - W40	204 LED	216 LED	75	8204	4000K	A++	1754	1555	5.05
NYB-80542 - 0 - W50	204 LED	216 LED	75	8545	5000K	A++	1754	1555	5.05
NYB-80551 - 0 - W27	276 LED	288 LED	73	7535	2700K	A++	2330	2130	6.32
NYB-80551 - 0 - W30	276 LED	288 LED	73	7881	3000K	A++	2330	2130	6.32
NYB-80551 - 0 - W40	276 LED	288 LED	73	8226	4000K	A++	2330	2130	6.32
NYB-80551 - 0 - W50	276 LED	288 LED	73	8568	5000K	A++	2330	2130	6.32
NYB-80552 - 0 - W27	276 LED	288 LED	100	10020	2700K	A++	2330	2130	6.32
NYB-80552 - 0 - W30	276 LED	288 LED	100	10480	3000K	A++	2330	2130	6.32
NYB-80552 - 0 - W40	276 LED	288 LED	100	10939	4000K	A++	2330	2130	6.32
NYB-80552 - 0 - W50	276 LED	288 LED	100	11394	5000K	A++	2330	2130	6.32
NYB-80561 - 0 - W27	348 LED	360 LED	91	9419	2700K	A++	2906	2705	7.59
NYB-80561 - 0 - W30	348 LED	360 LED	91	9851	3000K	A++	2906	2705	7.59
NYB-80561 - 0 - W40	348 LED	360 LED	91	10283	4000K	A++	2906	2705	7.59
NYB-80561 - 0 - W50	348 LED	360 LED	91	10711	5000K	A++	2906	2705	7.59
NYB-80562 - 0 - W27	348 LED	360 LED	124	12524	2700K	A++	2906	2705	7.59
NYB-80562 - 0 - W30	348 LED	360 LED	124	13099	3000K	A++	2906	2705	7.59
NYB-80562 - 0 - W40	348 LED	360 LED	124	13673	4000K	A++	2906	2705	7.59
NYB-80562 - 0 - W50	348 LED	360 LED	124	14242	5000K	A++	2906	2705	7.59

Accessory

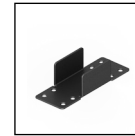

Continuous coupler bracket
(Nybro Up-Down 40mm.)
(A81681)

Colour Code

- 01	- 03	- 05	
			RESET
Black RAL 9011	White RAL 9003	Matt Silver RAL 9006	

* Installation manual available online at www.ligman.com.
* Luminous flux and system power are rated from absolute photometry according to LM-79-08 standard for LED luminaire.
* Photometric diagram for standard non-accessory, please consult the factory in case accessory option.

HEADQUARTERS EUROPE

Ligman Europe s.r.o.
VGP Park Ústí nad Labem, P2 | Přestanov 120 | 40317 Přestanov |
Czech Republic | Tel. +420 477 07 1500 | sales.cz@ligman.com
www.ligman.com

HEADQUARTERS THAILAND

Ligman Lighting Co., Ltd.
17/2 | Moo 4 | Monthong | Bangnampreaw | Chachoengsao 24150 |
Thailand | Tel : +66 (2) 7339140 | info@ligman.com

Ligman Ltd.
Victory Way | Crossways | Dartford DA2 6QD |
United Kingdom | Tel +66 2 733 9140 | Fax +66 2 733 9153 |
sales.uk@ligman.com

Technical amendments reserved.

Nybro 5 Dimming Type

Surface ceiling Up-Down light

Project :	Location :	Type :	Quantity :
Note :			

Product Code

Model No.	No. LED		System Power W	Lumen lm	Colour	EEC	Dimension		Weight kg
	Up	Down					L1	L2	

SURFACE CEILING MOUNTED · UP-DOWN LIGHT · 40x95MM. · DIMMING TYPE · MICRO-PRISMATIC DIFFUSER

NYB-80501 - P - W27	60 LED	72 LED	21	881	2700K	A++	602	400	2.51
NYB-80501 - P - W30	60 LED	72 LED	21	922	3000K	A++	602	400	2.51
NYB-80501 - P - W40	60 LED	72 LED	21	962	4000K	A++	602	400	2.51
NYB-80501 - P - W50	60 LED	72 LED	21	1002	5000K	A++	602	400	2.51
NYB-80502 - P - W27	60 LED	72 LED	28	1172	2700K	A++	602	400	2.51
NYB-80502 - P - W30	60 LED	72 LED	28	1226	3000K	A++	602	400	2.51
NYB-80502 - P - W40	60 LED	72 LED	28	1280	4000K	A++	602	400	2.51
NYB-80502 - P - W50	60 LED	72 LED	28	1333	5000K	A++	602	400	2.51
NYB-80511 - P - W27	96 LED	108 LED	29	1321	2700K	A++	890	700	3.15
NYB-80511 - P - W30	96 LED	108 LED	29	1381	3000K	A++	890	700	3.15
NYB-80511 - P - W40	96 LED	108 LED	29	1442	4000K	A++	890	700	3.15
NYB-80511 - P - W50	96 LED	108 LED	29	1502	5000K	A++	890	700	3.15
NYB-80512 - P - W27	96 LED	108 LED	39	1759	2700K	A++	890	700	3.15
NYB-80512 - P - W30	96 LED	108 LED	39	1839	3000K	A++	890	700	3.15
NYB-80512 - P - W40	96 LED	108 LED	39	1920	4000K	A++	890	700	3.15
NYB-80512 - P - W50	96 LED	108 LED	39	2000	5000K	A++	890	700	3.15
NYB-80521 - P - W27	132 LED	144 LED	39	1761	2700K	A++	1178	982	3.73
NYB-80521 - P - W30	132 LED	144 LED	39	1842	3000K	A++	1178	982	3.73
NYB-80521 - P - W40	132 LED	144 LED	39	1923	4000K	A++	1178	982	3.73
NYB-80521 - P - W50	132 LED	144 LED	39	2003	5000K	A++	1178	982	3.73
NYB-80522 - P - W27	132 LED	144 LED	50	2346	2700K	A++	1178	982	3.73
NYB-80522 - P - W30	132 LED	144 LED	50	2453	3000K	A++	1178	982	3.73
NYB-80522 - P - W40	132 LED	144 LED	50	2561	4000K	A++	1178	982	3.73
NYB-80522 - P - W50	132 LED	144 LED	50	2668	5000K	A++	1178	982	3.73
NYB-80531 - P - W27	168 LED	180 LED	47	2202	2700K	A++	1466	1265	4.42
NYB-80531 - P - W30	168 LED	180 LED	47	2303	3000K	A++	1466	1265	4.42
NYB-80531 - P - W40	168 LED	180 LED	47	2404	4000K	A++	1466	1265	4.42
NYB-80531 - P - W50	168 LED	180 LED	47	2504	5000K	A++	1466	1265	4.42
NYB-80532 - P - W27	168 LED	180 LED	63	2932	2700K	A++	1466	1265	4.42
NYB-80532 - P - W30	168 LED	180 LED	63	3067	3000K	A++	1466	1265	4.42
NYB-80532 - P - W40	168 LED	180 LED	63	3201	4000K	A++	1466	1265	4.42
NYB-80532 - P - W50	168 LED	180 LED	63	3334	5000K	A++	1466	1265	4.42
NYB-80541 - P - W27	204 LED	216 LED	56	2643	2700K	A++	1754	1555	5.05
NYB-80541 - P - W30	204 LED	216 LED	56	2764	3000K	A++	1754	1555	5.05
NYB-80541 - P - W40	204 LED	216 LED	56	2885	4000K	A++	1754	1555	5.05
NYB-80541 - P - W50	204 LED	216 LED	56	3005	5000K	A++	1754	1555	5.05
NYB-80542 - P - W27	204 LED	216 LED	75	3518	2700K	A++	1754	1555	5.05
NYB-80542 - P - W30	204 LED	216 LED	75	3680	3000K	A++	1754	1555	5.05
NYB-80542 - P - W40	204 LED	216 LED	75	3841	4000K	A++	1754	1555	5.05
NYB-80542 - P - W50	204 LED	216 LED	75	4001	5000K	A++	1754	1555	5.05
NYB-80551 - P - W27	276 LED	288 LED	73	3524	2700K	A++	2330	2130	6.32
NYB-80551 - P - W30	276 LED	288 LED	73	3685	3000K	A++	2330	2130	6.32
NYB-80551 - P - W40	276 LED	288 LED	73	3847	4000K	A++	2330	2130	6.32
NYB-80551 - P - W50	276 LED	288 LED	73	4007	5000K	A++	2330	2130	6.32
NYB-80552 - P - W27	276 LED	288 LED	100	4691	2700K	A++	2330	2130	6.32
NYB-80552 - P - W30	276 LED	288 LED	100	4906	3000K	A++	2330	2130	6.32
NYB-80552 - P - W40	276 LED	288 LED	100	5121	4000K	A++	2330	2130	6.32
NYB-80552 - P - W50	276 LED	288 LED	100	5334	5000K	A++	2330	2130	6.32
NYB-80561 - P - W27	348 LED	360 LED	91	4405	2700K	A++	2906	2705	7.59
NYB-80561 - P - W30	348 LED	360 LED	91	4607	3000K	A++	2906	2705	7.59
NYB-80561 - P - W40	348 LED	360 LED	91	4809	4000K	A++	2906	2705	7.59
NYB-80561 - P - W50	348 LED	360 LED	91	5009	5000K	A++	2906	2705	7.59
NYB-80562 - P - W27	348 LED	360 LED	124	5864	2700K	A++	2906	2705	7.59
NYB-80562 - P - W30	348 LED	360 LED	124	6133	3000K	A++	2906	2705	7.59
NYB-80562 - P - W40	348 LED	360 LED	124	6402	4000K	A++	2906	2705	7.59
NYB-80562 - P - W50	348 LED	360 LED	124	6668	5000K	A++	2906	2705	7.59

HEADQUARTERS EUROPE

Ligman Europe s.r.o.
 VGP Park Usti nad Labem, P2 | Přestanov 120 | 40317 Přestanov |
 Czech Republic | Tel. +420 477 07 1500 | sales.cz@ligman.com
 www.ligman.com

HEADQUARTERS THAILAND

Ligman Lighting Co., Ltd.
 17/2 | Moo 4 | Monthong | Bangnampreaw | Chachoengsao 24150 |
 Thailand | Tel : +66 2 7339140 | info@ligman.com

Ligman Ltd.
 Victory Way | Crossways | Dartford DA2 6QD |
 United Kingdom | Tel +66 2 733 9140 | Fax +66 2 733 9153 |
 sales.uk@ligman.com

Technical amendments reserved.

Nybro 5 Dimming Type

Surface ceiling Up-Down light

Project :	Location :	Type :	Quantity :
Note :			

Photometric

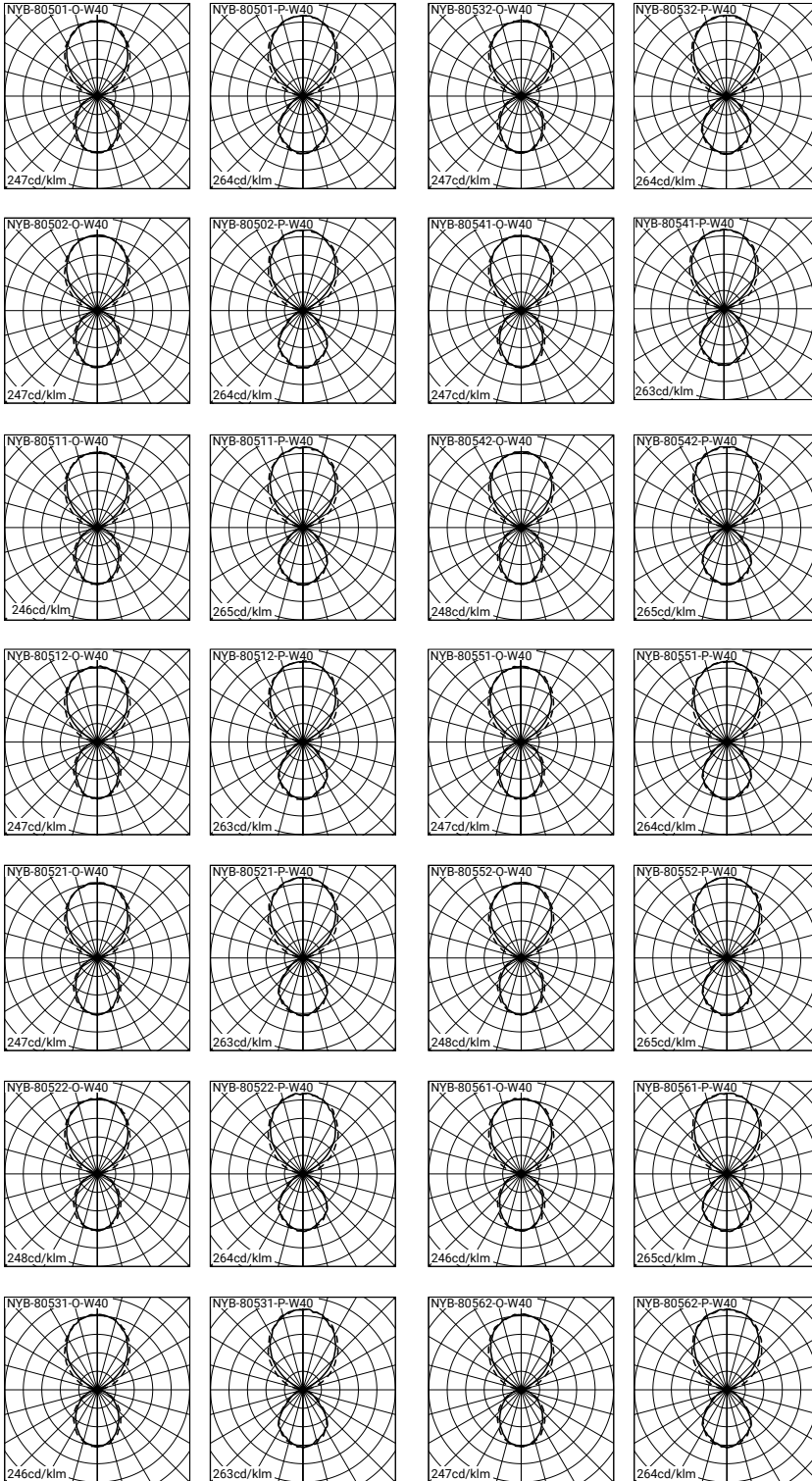

* Installation manual available online at www.ligman.com.
 • Luminous flux and system power are rated from absolute photometry according to LM-79-08 standard for LED luminaire.
 • Photometric diagram for standard non-accessory, please consult the factory in case accessory option.

HEADQUARTERS EUROPE

Ligman Europe s.r.o.
 VGP Park Ústí nad Labem, P2 | Přestanov 120 | 40317 Přestanov |
 Czech Republic | Tel. +420 477 07 1500 | sales.cz@ligman.com
www.ligman.com

HEADQUARTERS THAILAND

Ligman Lighting Co., Ltd.
 17/2 | Moo 4 | Monthong | Bangnampreaw | Chachoengsao 24150 |
 Thailand | Tel : +66 (2) 7339140 | info@ligman.com

Ligman Ltd.
 Victory Way | Crossways | Dartford DA2 6QD |
 United Kingdom | Tel +66 2 733 9140 | Fax +66 2 733 9153 |
sales.uk@ligman.com

Technical amendments reserved.

Nybro 5 Sensor Control

Surface ceiling Up-Down light

Project :	Location :	Type :	Quantity :
Note :			

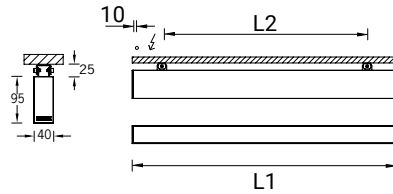
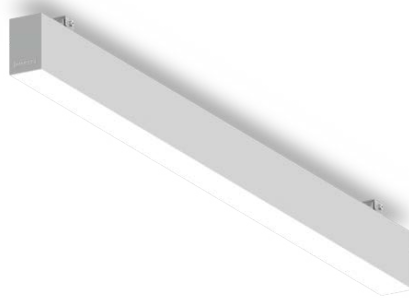

Luminaire Structure

Pendant, surface and suspended interior lighting system Powerful, flexible continuous illumination with a myriad of light source and control options

Light Symbol



Up - Down light

Ordering guide sample

NYB-80523	- O -	W30	- WBT	- A81681	Diffuser for light output control	Colour Temperature
		Colour	Sensor	Accessory	O - Opal diffuser UGR <19	W27 - Warm 2700K
					P - Micro-prismatic UGR <13	W30 - Warm white 3000K
						W40 - Neutral white 4000K
						W50 - Cool white 5000K

Optional diffuser



(- O)
Opal diffuser
UGR <19

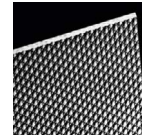

(- P)
Micro-prismatic diffuser
UGR <13

Product Code

Model No.	No. LED		System Power W	Lumen lm	Colour	EEC	Dimension		Weight kg
	Up	Down					L1	L2	

SURFACE CEILING MOUNTED · DOWN LIGHT · 40x80MM · SENSOR CONTROL · OPAL DIFFUSER

NYB-80523	- O -	W27	132 LED	132 LED	48	4827	2700K	A++	1178	980	3.98
NYB-80523	- O -	W30	132 LED	132 LED	48	5049	3000K	A++	1178	980	3.98
NYB-80523	- O -	W40	132 LED	132 LED	48	5270	4000K	A++	1178	980	3.98
NYB-80523	- O -	W50	132 LED	132 LED	48	5489	5000K	A++	1178	980	3.98
NYB-80533	- O -	W27	168 LED	168 LED	61	6079	2700K	A++	1466	1265	4.68
NYB-80533	- O -	W30	168 LED	168 LED	61	6358	3000K	A++	1466	1265	4.68
NYB-80533	- O -	W40	168 LED	168 LED	61	6637	4000K	A++	1466	1265	4.68
NYB-80533	- O -	W50	168 LED	168 LED	61	6913	5000K	A++	1466	1265	4.68
NYB-80543	- O -	W27	204 LED	204 LED	73	7332	2700K	A++	1754	1555	5.30
NYB-80543	- O -	W30	204 LED	204 LED	73	7668	3000K	A++	1754	1555	5.30
NYB-80543	- O -	W40	204 LED	204 LED	73	8004	4000K	A++	1754	1555	5.30
NYB-80543	- O -	W50	204 LED	204 LED	73	8337	5000K	A++	1754	1555	5.30
NYB-80553	- O -	W27	276 LED	276 LED	98	9837	2700K	A++	2330	2130	6.57
NYB-80553	- O -	W30	276 LED	276 LED	98	10288	3000K	A++	2330	2130	6.57
NYB-80553	- O -	W40	276 LED	276 LED	98	10739	4000K	A++	2330	2130	6.57
NYB-80553	- O -	W50	276 LED	276 LED	98	11186	5000K	A++	2330	2130	6.57
NYB-80563	- O -	W27	348 LED	348 LED	122	12341	2700K	A++	2906	2705	7.84
NYB-80563	- O -	W30	348 LED	348 LED	122	12907	3000K	A++	2906	2705	7.84
NYB-80563	- O -	W40	348 LED	348 LED	122	13473	4000K	A++	2906	2705	7.84
NYB-80563	- O -	W50	348 LED	348 LED	122	14033	5000K	A++	2906	2705	7.84

Accessory



Continuous coupler bracket
(Nybro Up-Down 40mm.)
(A81681)

Colour Code

- 01	- 03	- 05	RESET
Black RAL 9011	White RAL 9003	Matt Silver RAL 9006	

HEADQUARTERS EUROPE

Ligman Europe s.r.o.
VGP Park Usti nad Labem, P2 | Přestanov 120 | 40317 Přestanov |
Czech Republic | Tel. +420 477 07 1500 | sales.cz@ligman.com
www.ligman.com

HEADQUARTERS THAILAND

Ligman Lighting Co., Ltd.
17/2 | Moo 4 | Monthong | Bangnampreaw | Chachoengsao 24150 |
Thailand | Tel : +66 (2) 7339140 | info@ligman.com

Ligman Ltd.
Victory Way | Crossways | Dartford DA2 6QD |
United Kingdom | Tel +66 2 733 9140 | Fax +66 2 733 9153 |
sales.uk@ligman.com

Technical amendments reserved.

Nybro 5 Sensor Control

Surface ceiling Up-Down light

Project :	Location :	Type :	Quantity :
Note :			

Product Code

Model No.	No. LED		System Power W	Lumen lm	Colour	EEC	Dimension		Weight kg
	Up	Down					L1	L2	
SURFACE CEILING MOUNTED · DOWN LIGHT · 40x80MM · SENSOR CONTROL · MICRO-PRISMATIC DIFFUSER									
NYB-80523 - P - W27	132 LED	132 LED	48	4116	2700K	A++	1178	980	3.98
NYB-80523 - P - W30	132 LED	132 LED	48	4304	3000K	A++	1178	980	3.98
NYB-80523 - P - W40	132 LED	132 LED	48	4493	4000K	A++	1178	980	3.98
NYB-80523 - P - W50	132 LED	132 LED	48	4680	5000K	A++	1178	980	3.98
NYB-80533 - P - W27	168 LED	168 LED	61	5183	2700K	A++	1466	1265	4.68
NYB-80533 - P - W30	168 LED	168 LED	61	5420	3000K	A++	1466	1265	4.68
NYB-80533 - P - W40	168 LED	168 LED	61	5658	4000K	A++	1466	1265	4.68
NYB-80533 - P - W50	168 LED	168 LED	61	5893	5000K	A++	1466	1265	4.68
NYB-80543 - P - W27	204 LED	204 LED	73	6258	2700K	A++	1754	1555	5.30
NYB-80543 - P - W30	204 LED	204 LED	73	6545	3000K	A++	1754	1555	5.30
NYB-80543 - P - W40	204 LED	204 LED	73	6832	4000K	A++	1754	1555	5.30
NYB-80543 - P - W50	204 LED	204 LED	73	7116	5000K	A++	1754	1555	5.30
NYB-80553 - P - W27	276 LED	276 LED	98	8386	2700K	A++	2330	2130	6.57
NYB-80553 - P - W30	276 LED	276 LED	98	8770	3000K	A++	2330	2130	6.57
NYB-80553 - P - W40	276 LED	276 LED	98	9155	4000K	A++	2330	2130	6.57
NYB-80553 - P - W50	276 LED	276 LED	98	9536	5000K	A++	2330	2130	6.57
NYB-80563 - P - W27	348 LED	348 LED	122	10521	2700K	A++	2906	2705	7.84
NYB-80563 - P - W30	348 LED	348 LED	122	11004	3000K	A++	2906	2705	7.84
NYB-80563 - P - W40	348 LED	348 LED	122	11486	4000K	A++	2906	2705	7.84
NYB-80563 - P - W50	348 LED	348 LED	122	11964	5000K	A++	2906	2705	7.84

* Installation manual available online at www.ligman.com.

* Luminous flux and system power are rated from absolute photometry according to LM-79-08 standard for LED luminaire.
* Photometric diagram for standard non-accessory, please consult the factory in case accessory option.

HEADQUARTERS EUROPE

Ligman Europe s.r.o.
VGP Park Ústí nad Labem, P2 | Přestanov 120 | 40317 Přestanov |
Czech Republic | Tel. +420 477 07 1500 | sales.cz@ligman.com
www.ligman.com

HEADQUARTERS THAILAND

Ligman Lighting Co.,Ltd.
17/2 | Moo 4 | Monthong | Bangnampreaw | Chachoengsao 24150 |
Thailand | Tel : +66 (2) 7339140 | info@ligman.com

Ligman Ltd.
Victory Way | Crossways | Dartford DA2 6QD |
United Kingdom | Tel +66 2 733 9140 | Fax +66 2 733 9153 |
sales.uk@ligman.com

Technical amendments reserved.

Nybro 5 Tunable White

Surface ceiling Up-Down light

Project :	Location :	Type :	Quantity :
Note :			

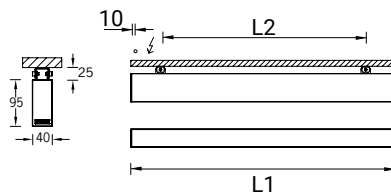
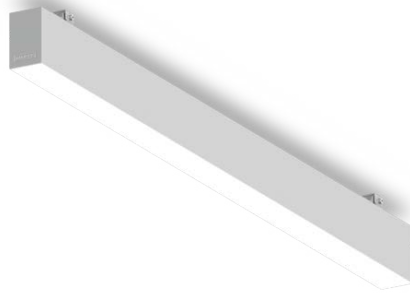

Luminaire Structure

Pendant, surface and suspended interior lighting system Powerful, flexible continuous illumination with a myriad of light source and control options

Light Symbol



Up - Down light

Ordering guide sample

NYB-80525 - O - TUV - A81681	Diffuser for light output control O - Opal diffuser UGR <19 P - Micro-prismatic UGR <13	Colour Temperature TUV - Tunable white 2700K - 6500K
<div style="display: flex; justify-content: space-around;"> <div style="border: 1px solid black; padding: 2px;">Diffuser</div> <div style="border: 1px solid black; padding: 2px;">Colour</div> <div style="border: 1px solid black; padding: 2px;">Accessory</div> </div>		

Optional diffuser

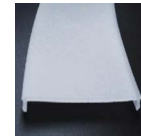

(- O)
Opal diffuser
UGR <19

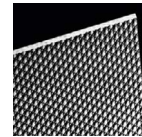

(- P)
Micro-prismatic diffuser
UGR <13

Product Code

Model No.		No. LED		System Power W	Lumen lm	Colour	EEC	Dimension		Weight kg
		Up	Down					L1	L2	
SURFACE CEILING MOUNTED · UP-DOWN LIGHT · 40x95MM. · TUNABLE WHITE · OPAL DIFFUSER										
NYB-80525	O - TUV	132 LED	144 LED	144	5269	TUV	A++	1178	980	3.73
NYB-80544	O - TUV	204 LED	216 LED	216	8004	TUV	A++	1754	1555	6.50
NYB-80554	O - TUV	276 LED	288 LED	288	10283	TUV	A++	2330	2130	7.32
NYB-80564	O - TUV	348 LED	360 LED	360	13441	TUV	A++	2906	2705	8.59
SURFACE CEILING MOUNTED · UP-DOWN LIGHT · 40x95MM. · TUNABLE WHITE · MICRO-PRISMATIC DIFFUSER										
NYB-80525	P - TUV	132 LED	144 LED	144	4492	TUV	A++	1178	980	3.73
NYB-80544	P - TUV	204 LED	216 LED	216	6823	TUV	A++	1754	1555	6.50
NYB-80554	P - TUV	276 LED	288 LED	288	8766	TUV	A++	2330	2130	7.32
NYB-80564	P - TUV	348 LED	360 LED	360	11458	TUV	A++	2906	2705	8.59

Wireless Bluetooth

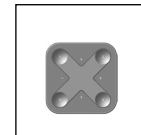

xPress Wireless switch
(A90591)



Wireless Bluetooth
(A90291)

Accessory

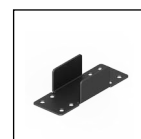

Continuous coupler bracket
(Nybro Up-Down 40mm.)
(A81681)

Colour Code

- 01	- 03	- 05	
Black RAL 9011	White RAL 9003	Matt Silver RAL 9006	RESET

HEADQUARTERS EUROPE

Ligman Europe s.r.o.
VGP Park Ústí nad Labem, P2 | Přestanov 120 | 40317 Přestanov |
Czech Republic | Tel. +420 477 07 1500 | sales.cz@ligman.com
www.ligman.com

HEADQUARTERS THAILAND

Ligman Lighting Co., Ltd.
17/2 | Moo 4 | Monthong | Bangnampreaw | Chachoengsao 24150 |
Thailand | Tel : +66 (2) 7339140 | info@ligman.com

Ligman Ltd.
Victory Way | Crossways | Dartford DA2 6QD |
United Kingdom | Tel +66 2 733 9140 | Fax +66 2 733 9153 |
sales.uk@ligman.com

Technical amendments reserved.

Nybro 6 Dimming Type

Surface ceiling Down light

Project :	Location :	Type :	Quantity :
Note :			

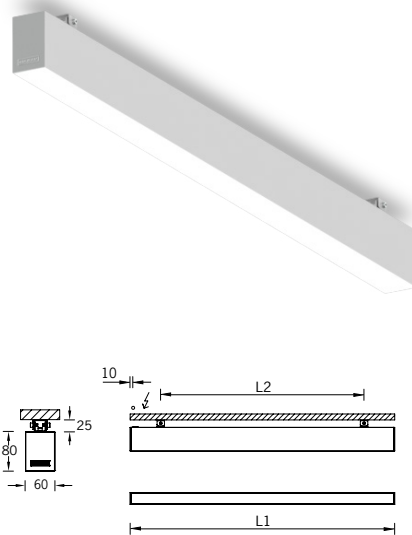

Luminaire Structure

Pendant, surface and suspended interior lighting system Powerful, flexible continuous illumination with a myriad of light source and control options

Light Symbol



Ordering guide sample

<p>NYB-80601 - O - W30 - DA - A81581</p> <p>Diffuser: O, Colour: W30, Dim Type: DA, Accessory: A81581</p>	<p>Diffuser for light output control</p> <p>O - Opal diffuser UGR <19</p> <p>P - Micro-prismatic UGR <13</p>	<p>Dimming Type</p> <p>ND - Non dimmable</p> <p>DI - 1-10V dimmable</p> <p>DA - DALI dimmable</p>	<p>Colour Temperature</p> <p>W27 - Warm 2700K</p> <p>W30 - Warm white 3000K</p> <p>W40 - Neutral white 4000K</p> <p>W50 - Cool white 5000K</p>
---	--	---	--

Product Code

Model No.	No. LED		System Power W	Lumen lm	Colour	EEC	Dimension		Weight kg
	Up	Down					L1	L2	
SURFACE CEILING MOUNTED · DOWN LIGHT · 60x80MM. · DIMMING TYPE · OPAL DIFFUSER									
NYB-80601 - O - W27	-	72 LED	11	1051	2700K	A++	602	396	2.17
NYB-80601 - O - W30	-	72 LED	11	1099	3000K	A++	602	396	2.17
NYB-80601 - O - W40	-	72 LED	11	1147	4000K	A++	602	396	2.17
NYB-80601 - O - W50	-	72 LED	11	1195	5000K	A++	602	396	2.17
NYB-80602 - O - W27	-	72 LED	14	1399	2700K	A++	602	396	2.17
NYB-80602 - O - W30	-	72 LED	14	1463	3000K	A++	602	396	2.17
NYB-80602 - O - W40	-	72 LED	14	1527	4000K	A++	602	396	2.17
NYB-80602 - O - W50	-	72 LED	14	1591	5000K	A++	602	396	2.17
NYB-80603 - O - W27	-	72 LED	19	1931	2700K	A++	602	396	2.17
NYB-80603 - O - W30	-	72 LED	19	2019	3000K	A++	602	396	2.17
NYB-80603 - O - W40	-	72 LED	19	2108	4000K	A++	602	396	2.17
NYB-80603 - O - W50	-	72 LED	19	2196	5000K	A++	602	396	2.17

Optional diffuser

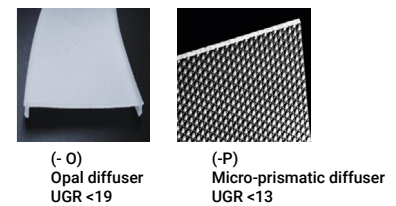

Dimming Type

ND DI DA

Colour Code

- 01	- 03	- 05	
Black RAL 9011	White RAL 9003	Matt Silver RAL 9006	RESET

HEADQUARTERS EUROPE

Ligman Europe s.r.o.
VGP Park Usti nad Labem, P2 | Přestanov 120 | 40317 Přestanov |
Czech Republic | Tel. +420 477 07 1500 | sales.cz@ligman.com
www.ligman.com

HEADQUARTERS THAILAND

Ligman Lighting Co., Ltd.
17/2 | Moo 4 | Monthong | Bangnampreaw | Chachoengsao 24150 |
Thailand | Tel : +66 (2) 7339140 | info@ligman.com

Ligman Ltd.
Victory Way | Crossways | Dartford DA2 6QD |
United Kingdom | Tel +66 2 733 9140 | Fax +66 2 733 9153 |
sales.uk@ligman.com

Technical amendments reserved.

Nybro 6 Dimming Type

Surface ceiling Down light

Project :	Location :	Type :	Quantity :
Note :			

Product Code

Model No.	No. LED		System Power W	Lumen lm	Colour	EEC	Dimension		Weight kg
	Up	Down					L1	L2	

SURFACE CEILING MOUNTED · DOWN LIGHT · 60x80MM · DIMMING TYPE · OPAL DIFFUSER

NYB-80611 - 0 - W27	-	108 LED	15	1576	2700K	A++	890	684	2.90
NYB-80611 - 0 - W30	-	108 LED	15	1648	3000K	A++	890	684	2.90
NYB-80611 - 0 - W40	-	108 LED	15	1720	4000K	A++	890	684	2.90
NYB-80611 - 0 - W50	-	108 LED	15	1792	5000K	A++	890	684	2.90
NYB-80612 - 0 - W27	-	108 LED	19	2099	2700K	A++	890	684	2.90
NYB-80612 - 0 - W30	-	108 LED	19	2195	3000K	A++	890	684	2.90
NYB-80612 - 0 - W40	-	108 LED	19	2291	4000K	A++	890	684	2.90
NYB-80612 - 0 - W50	-	108 LED	19	2386	5000K	A++	890	684	2.90
NYB-80613 - 0 - W27	-	108 LED	29	2895	2700K	A++	890	684	2.90
NYB-80613 - 0 - W30	-	108 LED	29	3028	3000K	A++	890	684	2.90
NYB-80613 - 0 - W40	-	108 LED	29	3161	4000K	A++	890	684	2.90
NYB-80613 - 0 - W50	-	108 LED	29	3292	5000K	A++	890	684	2.90
NYB-80621 - 0 - W27	-	144 LED	19	2100	2700K	A++	1178	972	3.64
NYB-80621 - 0 - W30	-	144 LED	19	2197	3000K	A++	1178	972	3.64
NYB-80621 - 0 - W40	-	144 LED	19	2293	4000K	A++	1178	972	3.64
NYB-80621 - 0 - W50	-	144 LED	19	2388	5000K	A++	1178	972	3.64
NYB-80622 - 0 - W27	-	144 LED	25	2798	2700K	A++	1178	972	3.64
NYB-80622 - 0 - W30	-	144 LED	25	2927	3000K	A++	1178	972	3.64
NYB-80622 - 0 - W40	-	144 LED	25	3055	4000K	A++	1178	972	3.64
NYB-80622 - 0 - W50	-	144 LED	25	3182	5000K	A++	1178	972	3.64
NYB-80623 - 0 - W27	-	144 LED	37	3861	2700K	A++	1178	972	3.64
NYB-80623 - 0 - W30	-	144 LED	37	4038	3000K	A++	1178	972	3.64
NYB-80623 - 0 - W40	-	144 LED	37	4215	4000K	A++	1178	972	3.64
NYB-80623 - 0 - W50	-	144 LED	37	4390	5000K	A++	1178	972	3.64
NYB-80631 - 0 - W27	-	180 LED	24	2626	2700K	A++	1466	1260	4.39
NYB-80631 - 0 - W30	-	180 LED	24	2747	3000K	A++	1466	1260	4.39
NYB-80631 - 0 - W40	-	180 LED	24	2867	4000K	A++	1466	1260	4.39
NYB-80631 - 0 - W50	-	180 LED	24	2986	5000K	A++	1466	1260	4.39
NYB-80632 - 0 - W27	-	180 LED	32	3497	2700K	A++	1466	1260	4.39
NYB-80632 - 0 - W30	-	180 LED	32	3658	3000K	A++	1466	1260	4.39
NYB-80632 - 0 - W40	-	180 LED	32	3818	4000K	A++	1466	1260	4.39
NYB-80632 - 0 - W50	-	180 LED	32	3977	5000K	A++	1466	1260	4.39
NYB-80633 - 0 - W27	-	180 LED	46	4826	2700K	A++	1466	1260	4.39
NYB-80633 - 0 - W30	-	180 LED	46	5048	3000K	A++	1466	1260	4.39
NYB-80633 - 0 - W40	-	180 LED	46	5269	4000K	A++	1466	1260	4.39
NYB-80633 - 0 - W50	-	180 LED	46	5488	5000K	A++	1466	1260	4.39
NYB-80641 - 0 - W27	-	216 LED	28	3151	2700K	A++	1754	1548	5.11
NYB-80641 - 0 - W30	-	216 LED	28	3296	3000K	A++	1754	1548	5.11
NYB-80641 - 0 - W40	-	216 LED	28	3440	4000K	A++	1754	1548	5.11
NYB-80641 - 0 - W50	-	216 LED	28	3583	5000K	A++	1754	1548	5.11
NYB-80642 - 0 - W27	-	216 LED	38	4197	2700K	A++	1754	1548	5.11
NYB-80642 - 0 - W30	-	216 LED	38	4390	3000K	A++	1754	1548	5.11
NYB-80642 - 0 - W40	-	216 LED	38	4582	4000K	A++	1754	1548	5.11
NYB-80642 - 0 - W50	-	216 LED	38	4773	5000K	A++	1754	1548	5.11
NYB-80643 - 0 - W27	-	216 LED	55	5792	2700K	A++	1754	1548	5.11
NYB-80643 - 0 - W30	-	216 LED	55	6057	3000K	A++	1754	1548	5.11
NYB-80643 - 0 - W40	-	216 LED	55	6323	4000K	A++	1754	1548	5.11
NYB-80643 - 0 - W50	-	216 LED	55	6586	5000K	A++	1754	1548	5.11

Accessory For Wireless Bluetooth

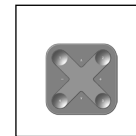

xPress Wireless switch (A90591)



Wireless Bluetooth (A90291)

Accessory

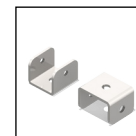

Bracket For Ceilings (A81281)



Continuous coupler bracket (A81581)

* Installation manual available online at www.ligman.com.

* Luminous flux and system power are rated from absolute photometry according to LM-79-08 standard for LED luminaire.
* Photometric diagram for standard non-accessory, please consult the factory in case accessory option.

HEADQUARTERS EUROPE

Ligman Europe s.r.o.
VGP Park Ústí nad Labem, P2 | Přestanov 120 | 40317 Přestanov |
Czech Republic | Tel. +420 477 07 1500 | sales.cz@ligman.com
www.ligman.com

HEADQUARTERS THAILAND

Ligman Lighting Co., Ltd.
17/2 | Moo 4 | Monthong | Bangnampreaw | Chachoengsao 24150 |
Thailand | Tel. +66 (2) 7339140 | info@ligman.com

Ligman Ltd.
Victory Way | Crossways | Dartford DA2 6QD |
United Kingdom | Tel. +66 2 733 9140 | Fax +66 2 733 9153 |
sales.uk@ligman.com

Technical amendments reserved.

Nybro 6 Dimming Type

Surface ceiling Down light

Project :	Location :	Type :	Quantity :
Note :			

Product Code

Model No.	No. LED		System Power W	Lumen lm	Colour	EEC	Dimension		Weight kg
	Up	Down					L1	L2	
SURFACE CEILING MOUNTED · DOWN LIGHT · 60x80MM. · DIMMING TYPE · OPAL DIFFUSER									
NYB-80651 - O - W27	-	288 LED	37	4202	2700K	A++	2330	2124	6.61
NYB-80651 - O - W30	-	288 LED	37	4394	3000K	A++	2330	2124	6.61
NYB-80651 - O - W40	-	288 LED	37	4587	4000K	A++	2330	2124	6.61
NYB-80651 - O - W50	-	288 LED	37	4778	5000K	A++	2330	2124	6.61
NYB-80652 - O - W27	-	288 LED	50	5596	2700K	A++	2330	2124	6.61
NYB-80652 - O - W30	-	288 LED	50	5852	3000K	A++	2330	2124	6.61
NYB-80652 - O - W40	-	288 LED	50	6109	4000K	A++	2330	2124	6.61
NYB-80652 - O - W50	-	288 LED	50	6363	5000K	A++	2330	2124	6.61
NYB-80653 - O - W27	-	288 LED	74	7722	2700K	A++	2330	2124	6.61
NYB-80653 - O - W30	-	288 LED	74	8076	3000K	A++	2330	2124	6.61
NYB-80653 - O - W40	-	288 LED	74	8430	4000K	A++	2330	2124	6.61
NYB-80653 - O - W50	-	288 LED	74	8781	5000K	A++	2330	2124	6.61
NYB-80661 - O - W27	-	360 LED	46	5251	2700K	A++	2906	2700	8.10
NYB-80661 - O - W30	-	360 LED	46	5492	3000K	A++	2906	2700	8.10
NYB-80661 - O - W40	-	360 LED	46	5733	4000K	A++	2906	2700	8.10
NYB-80661 - O - W50	-	360 LED	46	5971	5000K	A++	2906	2700	8.10
NYB-80662 - O - W27	-	360 LED	62	6995	2700K	A++	2906	2700	8.10
NYB-80662 - O - W30	-	360 LED	62	7315	3000K	A++	2906	2700	8.10
NYB-80662 - O - W40	-	360 LED	62	7636	4000K	A++	2906	2700	8.10
NYB-80662 - O - W50	-	360 LED	62	7954	5000K	A++	2906	2700	8.10
NYB-80663 - O - W27	-	360 LED	92	9653	2700K	A++	2906	2700	8.10
NYB-80663 - O - W30	-	360 LED	92	10095	3000K	A++	2906	2700	8.10
NYB-80663 - O - W40	-	360 LED	92	10538	4000K	A++	2906	2700	8.10
NYB-80663 - O - W50	-	360 LED	92	10976	5000K	A++	2906	2700	8.10

Product Code

Model No.	No. LED		System Power W	Lumen lm	Colour	EEC	Dimension		Weight kg
	Up	Down					L1	L2	
SURFACE CEILING MOUNTED · DOWN LIGHT · 60x80MM. · DIMMING TYPE · MICRO-PRISMATIC DIFFUSER									
NYB-80601 - P - W27	-	72 LED	11	896	2700K	A++	602	396	2.17
NYB-80601 - P - W30	-	72 LED	11	937	3000K	A++	602	396	2.17
NYB-80601 - P - W40	-	72 LED	11	978	4000K	A++	602	396	2.17
NYB-80601 - P - W50	-	72 LED	11	1018	5000K	A++	602	396	2.17
NYB-80602 - P - W27	-	72 LED	14	1192	2700K	A++	602	396	2.17
NYB-80602 - P - W30	-	72 LED	14	1247	3000K	A++	602	396	2.17
NYB-80602 - P - W40	-	72 LED	14	1302	4000K	A++	602	396	2.17
NYB-80602 - P - W50	-	72 LED	14	1356	5000K	A++	602	396	2.17
NYB-80603 - P - W27	-	72 LED	19	1646	2700K	A++	602	396	2.17
NYB-80603 - P - W30	-	72 LED	19	1722	3000K	A++	602	396	2.17
NYB-80603 - P - W40	-	72 LED	19	1797	4000K	A++	602	396	2.17
NYB-80603 - P - W50	-	72 LED	19	1872	5000K	A++	602	396	2.17

HEADQUARTERS EUROPE

Ligman Europe s.r.o.
 VGP Park Usti nad Labem, P2 | Přestanov 120 | 40317 Přestanov |
 Czech Republic | Tel. +420 477 07 1500 | sales.cz@ligman.com
 www.ligman.com

HEADQUARTERS THAILAND

Ligman Lighting Co., Ltd.
 17/2 | Moo 4 | Monthong | Bangnampreaw | Chachoengsao 24150 |
 Thailand | Tel : +66 (2) 7339140 | info@ligman.com

Ligman Ltd.
 Victory Way | Crossways | Dartford DA2 6QD |
 United Kingdom | Tel +66 2 733 9140 | Fax +66 2 733 9153 |
 sales.uk@ligman.com

Technical amendments reserved.

Nybro 6 Dimming Type

Surface ceiling Down light

Project :	Location :	Type :	Quantity :
Note :			

Product Code

Model No.	No. LED		System Power W	Lumen lm	Colour	EEC	Dimension		Weight kg
	Up	Down					L1	L2	

SURFACE CEILING MOUNTED · DOWN LIGHT · 60x80MM. · DIMMING TYPE · MICRO-PRISMATIC DIFFUSER

NYB-80611 - P - W27	-	108 LED	15	1343	2700K	A++	890	684	2.90
NYB-80611 - P - W30	-	108 LED	15	1405	3000K	A++	890	684	2.90
NYB-80611 - P - W40	-	108 LED	15	1466	4000K	A++	890	684	2.90
NYB-80611 - P - W50	-	108 LED	15	1527	5000K	A++	890	684	2.90
NYB-80612 - P - W27	-	108 LED	19	1789	2700K	A++	890	684	2.90
NYB-80612 - P - W30	-	108 LED	19	1871	3000K	A++	890	684	2.90
NYB-80612 - P - W40	-	108 LED	19	1953	4000K	A++	890	684	2.90
NYB-80612 - P - W50	-	108 LED	19	2034	5000K	A++	890	684	2.90
NYB-80613 - P - W27	-	108 LED	29	2468	2700K	A++	890	684	2.90
NYB-80613 - P - W30	-	108 LED	29	2582	3000K	A++	890	684	2.90
NYB-80613 - P - W40	-	108 LED	29	2695	4000K	A++	890	684	2.90
NYB-80613 - P - W50	-	108 LED	29	2807	5000K	A++	890	684	2.90
NYB-80621 - P - W27	-	144 LED	19	1791	2700K	A++	1178	972	3.64
NYB-80621 - P - W30	-	144 LED	19	1873	3000K	A++	1178	972	3.64
NYB-80621 - P - W40	-	144 LED	19	1955	4000K	A++	1178	972	3.64
NYB-80621 - P - W50	-	144 LED	19	2036	5000K	A++	1178	972	3.64
NYB-80622 - P - W27	-	144 LED	25	2386	2700K	A++	1178	972	3.64
NYB-80622 - P - W30	-	144 LED	25	2495	3000K	A++	1178	972	3.64
NYB-80622 - P - W40	-	144 LED	25	2604	4000K	A++	1178	972	3.64
NYB-80622 - P - W50	-	144 LED	25	2713	5000K	A++	1178	972	3.64
NYB-80623 - P - W27	-	144 LED	37	3291	2700K	A++	1178	972	3.64
NYB-80623 - P - W30	-	144 LED	37	3442	3000K	A++	1178	972	3.64
NYB-80623 - P - W40	-	144 LED	37	3593	4000K	A++	1178	972	3.64
NYB-80623 - P - W50	-	144 LED	37	3743	5000K	A++	1178	972	3.64
NYB-80631 - P - W27	-	180 LED	24	2239	2700K	A++	1466	1260	4.39
NYB-80631 - P - W30	-	180 LED	24	2341	3000K	A++	1466	1260	4.39
NYB-80631 - P - W40	-	180 LED	24	2444	4000K	A++	1466	1260	4.39
NYB-80631 - P - W50	-	180 LED	24	2546	5000K	A++	1466	1260	4.39
NYB-80632 - P - W27	-	180 LED	32	2981	2700K	A++	1466	1260	4.39
NYB-80632 - P - W30	-	180 LED	32	3118	3000K	A++	1466	1260	4.39
NYB-80632 - P - W40	-	180 LED	32	3255	4000K	A++	1466	1260	4.39
NYB-80632 - P - W50	-	180 LED	32	3390	5000K	A++	1466	1260	4.39
NYB-80633 - P - W27	-	180 LED	46	4115	2700K	A++	1466	1260	4.39
NYB-80633 - P - W30	-	180 LED	46	4303	3000K	A++	1466	1260	4.39
NYB-80633 - P - W40	-	180 LED	46	4492	4000K	A++	1466	1260	4.39
NYB-80633 - P - W50	-	180 LED	46	4679	5000K	A++	1466	1260	4.39
NYB-80641 - P - W27	-	216 LED	28	2686	2700K	A++	1754	1548	5.11
NYB-80641 - P - W30	-	216 LED	28	2809	3000K	A++	1754	1548	5.11
NYB-80641 - P - W40	-	216 LED	28	2933	4000K	A++	1754	1548	5.11
NYB-80641 - P - W50	-	216 LED	28	3055	5000K	A++	1754	1548	5.11
NYB-80642 - P - W27	-	216 LED	38	3578	2700K	A++	1754	1548	5.11
NYB-80642 - P - W30	-	216 LED	38	3742	3000K	A++	1754	1548	5.11
NYB-80642 - P - W40	-	216 LED	38	3906	4000K	A++	1754	1548	5.11
NYB-80642 - P - W50	-	216 LED	38	4069	5000K	A++	1754	1548	5.11
NYB-80643 - P - W27	-	216 LED	55	4938	2700K	A++	1754	1548	5.11
NYB-80643 - P - W30	-	216 LED	55	5164	3000K	A++	1754	1548	5.11
NYB-80643 - P - W40	-	216 LED	55	5390	4000K	A++	1754	1548	5.11
NYB-80643 - P - W50	-	216 LED	55	5615	5000K	A++	1754	1548	5.11

 * Installation manual available online at www.ligman.com.

* Luminous flux and system power are rated from absolute photometry according to LM-79-08 standard for LED luminaire.

* Photometric diagram for standard non-accessory, please consult the factory in case accessory option.

HEADQUARTERS EUROPE

Ligman Europe s.r.o.
 VGP Park Ústí nad Labem, P2 | Přestanov 120 | 40317 Přestanov |
 Czech Republic | Tel. +420 477 07 1500 | sales.cz@ligman.com
www.ligman.com

HEADQUARTERS THAILAND

Ligman Lighting Co., Ltd.
 17/2 | Moo 4 | Monthong | Bangnampreaw | Chachoengsao 24150 |
 Thailand | Tel: +66 (2) 7339140 | info@ligman.com

Ligman Ltd.
 Victory Way | Crossways | Dartford DA2 6QD |
 United Kingdom | Tel +66 2 733 9140 | Fax +66 2 733 9153 |
sales.uk@ligman.com

Technical amendments reserved.

Nybro 6 Dimming Type

Surface ceiling Down light

Project :	Location :	Type :	Quantity :
Note :			

Product Code

Model No.	No. LED		System Power W	Lumen lm	Colour	EEC	Dimension		Weight kg
	Up	Down					L1	L2	

SURFACE CEILING MOUNTED · DOWN LIGHT · 60x80MM. · DIMMING TYPE · MICRO-PRISMATIC DIFFUSER

NYB-80651 - P - W27	-	288 LED	37	3582	2700K	A++	2330	2124	6.61
NYB-80651 - P - W30	-	288 LED	37	3746	3000K	A++	2330	2124	6.61
NYB-80651 - P - W40	-	288 LED	37	3910	4000K	A++	2330	2124	6.61
NYB-80651 - P - W50	-	288 LED	37	4073	5000K	A++	2330	2124	6.61
NYB-80652 - P - W27	-	288 LED	50	4770	2700K	A++	2330	2124	6.61
NYB-80652 - P - W30	-	288 LED	50	4989	3000K	A++	2330	2124	6.61
NYB-80652 - P - W40	-	288 LED	50	5208	4000K	A++	2330	2124	6.61
NYB-80652 - P - W50	-	288 LED	50	5425	5000K	A++	2330	2124	6.61
NYB-80653 - P - W27	-	288 LED	74	6583	2700K	A++	2330	2124	6.61
NYB-80653 - P - W30	-	288 LED	74	6885	3000K	A++	2330	2124	6.61
NYB-80653 - P - W40	-	288 LED	74	7187	4000K	A++	2330	2124	6.61
NYB-80653 - P - W50	-	288 LED	74	7486	5000K	A++	2330	2124	6.61
NYB-80661 - P - W27	-	360 LED	46	4477	2700K	A++	2906	2700	8.10
NYB-80661 - P - W30	-	360 LED	46	4682	3000K	A++	2906	2700	8.10
NYB-80661 - P - W40	-	360 LED	46	4887	4000K	A++	2906	2700	8.10
NYB-80661 - P - W50	-	360 LED	46	5091	5000K	A++	2906	2700	8.10
NYB-80662 - P - W27	-	360 LED	62	5963	2700K	A++	2906	2700	8.10
NYB-80662 - P - W30	-	360 LED	62	6236	3000K	A++	2906	2700	8.10
NYB-80662 - P - W40	-	360 LED	62	6510	4000K	A++	2906	2700	8.10
NYB-80662 - P - W50	-	360 LED	62	6780	5000K	A++	2906	2700	8.10
NYB-80663 - P - W27	-	360 LED	92	8229	2700K	A++	2906	2700	8.10
NYB-80663 - P - W30	-	360 LED	92	8606	3000K	A++	2906	2700	8.10
NYB-80663 - P - W40	-	360 LED	92	8984	4000K	A++	2906	2700	8.10
NYB-80663 - P - W50	-	360 LED	92	9357	5000K	A++	2906	2700	8.10

Photometric

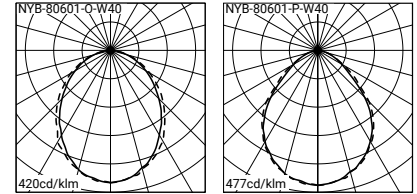

HEADQUARTERS EUROPE

Ligman Europe s.r.o.
VGP Park Usti nad Labem, P2 | Přestanov 120 | 40317 Přestanov |
Czech Republic | Tel. +420 477 07 1500 | sales.cz@ligman.com
www.ligman.com

HEADQUARTERS THAILAND

Ligman Lighting Co.,Ltd.
17/2 | Moo 4 | Monthong | Bangnampreaw | Chachoengsao 24150 |
Thailand | Tel : +66 (2) 7339140 | info@ligman.com

Ligman Ltd.
Victory Way | Crossways | Dartford DA2 6QD |
United Kingdom | Tel +66 2 733 9140 | Fax +66 2 733 9153 |
sales.uk@ligman.com

Technical amendments reserved.

Nybro 6 RGBW DMX

Surface ceiling Down light

Project :	Location :	Type :	Quantity :
Note :			

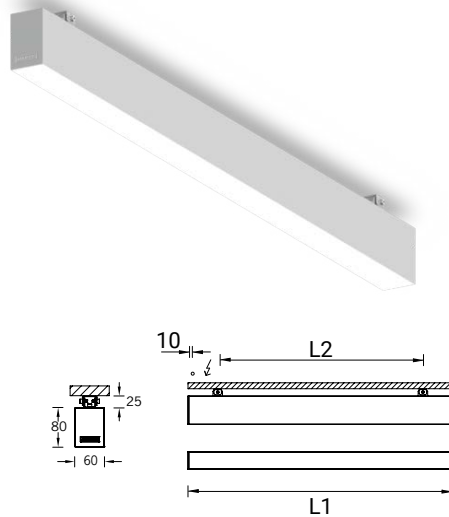

Luminaire Structure

Pendant, surface and suspended interior lighting system Powerful, flexible continuous illumination with a myriad of light source and control options

Light Symbol

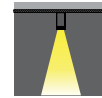

Down light

Optional diffuser

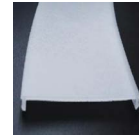

(- O)
Opal diffuser
UGR <19

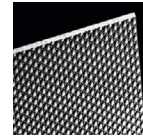

(- P)
Micro-prismatic diffuser
UGR <13

Ordering guide sample

NYB-80627	- O -	RGBW40	- A81581	Diffuser for light output control	Colour Temperature
				O - Opal diffuser UGR <19	W40 - Neutral white 4000K
				P - Micro-prismatic UGR <13	RGBW

Product Code

Model No.	No. LED		System Power W	Lumen lm	Colour	EEC	Dimension		Weight kg
	Up	Down					L1	L2	

SURFACE CEILING MOUNTED · DOWN LIGHT · 60x80MM. · RGBW DMX · OPAL DIFFUSER

NYB-80627	- O -	RGBW	-	192 LED	42	2000	RGBW40	A++	1178	972	3.64
NYB-80637	- O -	RGBW	-	240 LED	53	2500	RGBW40	A++	1466	1260	4.39
NYB-80647	- O -	RGBW	-	288 LED	63	3000	RGBW40	A++	1754	1548	5.11
NYB-80657	- O -	RGBW	-	384 LED	84	4000	RGBW40	A++	2330	2124	6.66
NYB-80667	- O -	RGBW	-	480 LED	105	5000	RGBW40	A++	2906	2700	8.60

SURFACE CEILING MOUNTED · DOWN LIGHT · 60x80MM. · RGBW DMX · MICRO-PRISMATIC DIFFUSER

NYB-80627	- P -	RGBW	-	192 LED	42	1705	RGBW40	A++	1178	972	3.64
NYB-80637	- P -	RGBW	-	240 LED	53	2131	RGBW40	A++	1466	1260	4.39
NYB-80647	- P -	RGBW	-	288 LED	63	2558	RGBW40	A++	1754	1548	5.11
NYB-80657	- P -	RGBW	-	384 LED	84	3410	RGBW40	A++	2330	2124	6.66
NYB-80667	- P -	RGBW	-	480 LED	105	4263	RGBW40	A++	2906	2700	8.60

Colour Code

- 01	- 03	- 05	
Black RAL 9011	White RAL 9003	Matt Silver RAL 9006	RESET

Colour Temperature

RGBW40

DMX Accessory



SLESA-U9
(A60491)



SLESA-UE7
(A60691)



STICK-KE1
(A60791)

Accessory

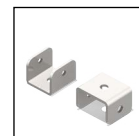

Bracket For
Ceilings
(A81281)



Continuous coupler
bracket
(A81581)

HEADQUARTERS EUROPE

Ligman Europe s.r.o.
VGP Park Ústí nad Labem, P2 | Přestanov 120 | 40317 Přestanov |
Czech Republic | Tel. +420 477 07 1500 | sales.cz@ligman.com
www.ligman.com

HEADQUARTERS THAILAND

Ligman Lighting Co., Ltd.
17/2 | Moo 4 | Monthong | Bangnampreaw | Chachoengsao 24150 |
Thailand | Tel : +66 (2) 7339140 | info@ligman.com

Ligman Ltd.
Victory Way | Crossways | Dartford DA2 6QD |
United Kingdom | Tel +66 2 733 9140 | Fax +66 2 733 9153 |
sales.uk@ligman.com

Technical amendments reserved.

Nybro 6 RGBW Wireless Bluetooth Surface ceiling Down light

Project :	Location :	Type :	Quantity :
Note :			

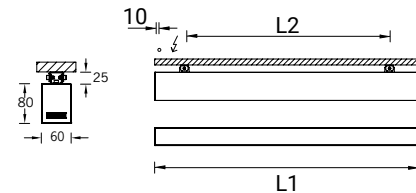
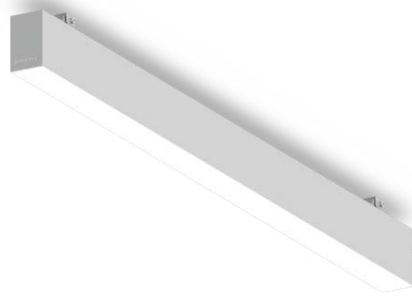

Luminaire Structure

Pendant, surface and suspended interior lighting system Powerful, flexible continuous illumination with a myriad of light source and control options

Light Symbol



Down light

Optional diffuser



(- O)
Opal diffuser
UGR <19

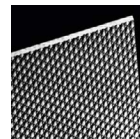

(-P)
Micro-prismatic diffuser
UGR <13

Ordering guide sample

NYB-80626	- O -	RGBW40	- A81581		
	Diffuser	Colour	Accessory	Diffuser for light output control	Colour Temperature
				O - Opal diffuser UGR <19	W40 - Neutral white 4000K
				P - Micro-prismatic UGR <13	RGBW

Product Code

Model No.	No. LED		System Power W	Lumen lm	Colour	EEC	Dimension		Weight kg
	Up	Down					L1	L2	

SURFACE CEILING MOUNTED-DOWN LIGHT-60x80MM. ·RGBW WIRELESS BLUETOOTH-OPAL DIFFUSER

NYB-80626	- O - RGBW	-	192 LED	42	2000	RGBW40	A++	1178	972	3.64
NYB-80636	- O - RGBW	-	240 LED	53	2500	RGBW40	A++	1466	1260	4.39
NYB-80646	- O - RGBW	-	288 LED	63	3000	RGBW40	A++	1754	1548	5.11
NYB-80656	- O - RGBW	-	384 LED	84	4000	RGBW40	A++	2330	2124	6.66
NYB-80666	- O - RGBW	-	480 LED	105	5000	RGBW40	A++	2906	2700	8.60

SURFACE CEILING MOUNTED-DOWN LIGHT-60x80MM. ·RGBW WIRELESS BLUETOOTH-MICRO-PRISMATIC DIFFUSER

NYB-80626	- P - RGBW	-	192 LED	42	1705	RGBW40	A++	1178	972	3.64
NYB-80636	- P - RGBW	-	240 LED	53	2131	RGBW40	A++	1466	1260	4.39
NYB-80646	- P - RGBW	-	288 LED	63	2558	RGBW40	A++	1754	1548	5.11
NYB-80656	- P - RGBW	-	384 LED	84	3410	RGBW40	A++	2330	2124	6.66
NYB-80666	- P - RGBW	-	480 LED	105	4263	RGBW40	A++	2906	2700	8.60

Colour Code

- 01	- 03	- 05	
Black RAL 9011	White RAL 9003	Matt Silver RAL 9006	RESET

Colour Temperature

RGBW40

Accessory For Wireless Bluetooth

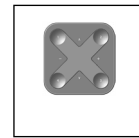

xPress Wireless switch
(A90591)

Accessory

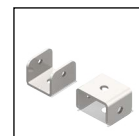

Bracket For Ceilings
(A81281)



Continuous coupler bracket
(A81581)

HEADQUARTERS EUROPE

Ligman Europe s.r.o.
VGP Park Usti nad Labem, P2 | Přestanov 120 | 40317 Přestanov |
Czech Republic | Tel. +420 477 07 1500 | sales.cz@ligman.com
www.ligman.com

HEADQUARTERS THAILAND

Ligman Lighting Co., Ltd.
17/2 | Moo 4 | Monthong | Bangnampreaw | Chachoengsao 24150 |
Thailand | Tel : +66 (2) 7339140 | info@ligman.com

Ligman Ltd.
Victory Way | Crossways | Dartford DA2 6QD |
United Kingdom | Tel +66 2 733 9140 | Fax +66 2 733 9153 |
sales.uk@ligman.com

Technical amendments reserved.

Nybro 6 Sensor Control

Surface ceiling Down light

Project :	Location :	Type :	Quantity :
Note :			

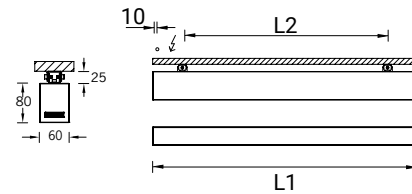
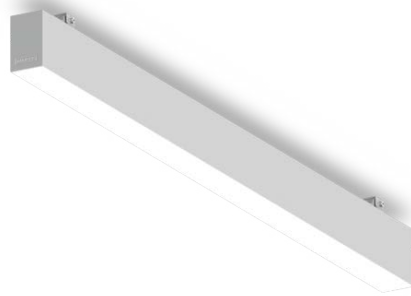

Luminaire Structure

Pendant, surface and suspended interior lighting system Powerful, flexible continuous illumination with a myriad of light source and control options

Light Symbol

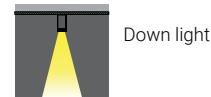

Ordering guide sample

NYB-80624 - O - W30 - WBT - A81581

Diffuser: O, Colour: W30, Sensor: WBT, Accessory: A81581

Diffuser for light output control
 O - Opal diffuser UGR <19
 P - Micro-prismatic UGR <13

Colour Temperature
 W27 - Warm 2700K
 W30 - Warm white 3000K
 W40 - Neutral white 4000K
 W50 - Cool white 5000K

Optional diffuser



(- O)
Opal diffuser
UGR <19

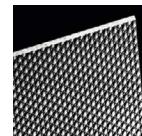

(- P)
Micro-prismatic diffuser
UGR <13

Product Code

Model No.	No. LED		System Power W	Lumen lm	Colour	EEC	Dimension		Weight kg
	Up	Down					L1	L2	

SURFACE CEILING MOUNTED · DOWN LIGHT · 60x80MM. · SENSOR CONTROL · OPAL DIFFUSER

NYB-80624 - O - W27	-	132 LED	35	3664	2700K	A++	1178	972	3.89
NYB-80624 - O - W30	-	132 LED	35	3832	3000K	A++	1178	972	3.89
NYB-80624 - O - W40	-	132 LED	35	4000	4000K	A++	1178	972	3.89
NYB-80624 - O - W50	-	132 LED	35	4166	5000K	A++	1178	972	3.89
NYB-80634 - O - W27	-	168 LED	44	4580	2700K	A++	1466	1260	4.64
NYB-80634 - O - W30	-	168 LED	44	4790	3000K	A++	1466	1260	4.64
NYB-80634 - O - W40	-	168 LED	44	5000	4000K	A++	1466	1260	4.64
NYB-80634 - O - W50	-	168 LED	44	5208	5000K	A++	1466	1260	4.64
NYB-80644 - O - W27	-	204 LED	53	5588	2700K	A++	1754	1548	5.36
NYB-80644 - O - W30	-	204 LED	53	5844	3000K	A++	1754	1548	5.36
NYB-80644 - O - W40	-	204 LED	53	6100	4000K	A++	1754	1548	5.36
NYB-80644 - O - W50	-	204 LED	53	6354	5000K	A++	1754	1548	5.36
NYB-80654 - O - W27	-	276 LED	72	7511	2700K	A++	2330	2124	6.86
NYB-80654 - O - W30	-	276 LED	72	7856	3000K	A++	2330	2124	6.86
NYB-80654 - O - W40	-	276 LED	72	8200	4000K	A++	2330	2124	6.86
NYB-80654 - O - W50	-	276 LED	72	8541	5000K	A++	2330	2124	6.86
NYB-80664 - O - W27	-	348 LED	90	9435	2700K	A++	2906	2700	8.35
NYB-80664 - O - W30	-	348 LED	90	9867	3000K	A++	2906	2700	8.35
NYB-80664 - O - W40	-	348 LED	90	10300	4000K	A++	2906	2700	8.35
NYB-80664 - O - W50	-	348 LED	90	10728	5000K	A++	2906	2700	8.35

Accessory

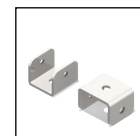

Bracket For
Ceilings
(A81281)



Continuous
coupler bracket
(A81581)

Colour Code

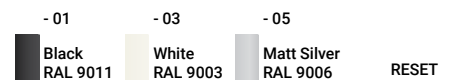

HEADQUARTERS EUROPE

Ligman Europe s.r.o.
 VGP Park Usti nad Labem, P2 | Přestanov 120 | 40317 Přestanov |
 Czech Republic | Tel. +420 477 07 1500 | sales.cz@ligman.com
 www.ligman.com

HEADQUARTERS THAILAND

Ligman Lighting Co., Ltd.
 17/2 | Moo 4 | Monthong | Bangnampreaw | Chachoengsao 24150 |
 Thailand | Tel : +66 (2) 7339140 | info@ligman.com

Ligman Ltd.
 Victory Way | Crossways | Dartford DA2 6QD |
 United Kingdom | Tel +66 2 733 9140 | Fax +66 2 733 9153 |
 sales.uk@ligman.com

Technical amendments reserved.

Nybro 6 Sensor Control

Surface ceiling Down light

Project :	Location :	Type :	Quantity :
Note :			

Product Code

Model No.	No. LED		System Power W	Lumen lm	Colour	EEC	Dimension		Weight kg
	Up	Down					L1	L2	
SURFACE CEILING MOUNTED · DOWN LIGHT · 60x80MM · SENSOR CONTROL · MICRO-PRISMATIC DIFFUSER									
NYB-80624 - P - W27	-	132 LED	35	3124	2700K	A++	1178	972	3.89
NYB-80624 - P - W30	-	132 LED	35	3267	3000K	A++	1178	972	3.89
NYB-80624 - P - W40	-	132 LED	35	3410	4000K	A++	1178	972	3.89
NYB-80624 - P - W50	-	132 LED	35	3552	5000K	A++	1178	972	3.89
NYB-80634 - P - W27	-	168 LED	44	3905	2700K	A++	1466	1260	4.64
NYB-80634 - P - W30	-	168 LED	44	4084	3000K	A++	1466	1260	4.64
NYB-80634 - P - W40	-	168 LED	44	4263	4000K	A++	1466	1260	4.64
NYB-80634 - P - W50	-	168 LED	44	4440	5000K	A++	1466	1260	4.64
NYB-80644 - P - W27	-	204 LED	53	4763	2700K	A++	1754	1548	5.36
NYB-80644 - P - W30	-	204 LED	53	4982	3000K	A++	1754	1548	5.36
NYB-80644 - P - W40	-	204 LED	53	5200	4000K	A++	1754	1548	5.36
NYB-80644 - P - W50	-	204 LED	53	5416	5000K	A++	1754	1548	5.36
NYB-80654 - P - W27	-	276 LED	72	6404	2700K	A++	2330	2124	6.86
NYB-80654 - P - W30	-	276 LED	72	6697	3000K	A++	2330	2124	6.86
NYB-80654 - P - W40	-	276 LED	72	6991	4000K	A++	2330	2124	6.86
NYB-80654 - P - W50	-	276 LED	72	7282	5000K	A++	2330	2124	6.86
NYB-80664 - P - W27	-	348 LED	90	8043	2700K	A++	2906	2700	8.35
NYB-80664 - P - W30	-	348 LED	90	8412	3000K	A++	2906	2700	8.35
NYB-80664 - P - W40	-	348 LED	90	8781	4000K	A++	2906	2700	8.35
NYB-80664 - P - W50	-	348 LED	90	9146	5000K	A++	2906	2700	8.35

* Installation manual available online at www.ligman.com.

* Luminous flux and system power are rated from absolute photometry according to LM-79-08 standard for LED luminaire.
* Photometric diagram for standard non-accessory, please consult the factory in case accessory option.

HEADQUARTERS EUROPE

Ligman Europe s.r.o.
VGP Park Ústí nad Labem, P2 | Přestanov 120 | 40317 Přestanov |
Czech Republic | Tel. +420 477 07 1500 | sales.cz@ligman.com
www.ligman.com

HEADQUARTERS THAILAND

Ligman Lighting Co.,Ltd.
17/2 | Moo 4 | Monthong | Bangnampreaw | Chachoengsao 24150 |
Thailand | Tel : +66 (2) 7339140 | info@ligman.com

Ligman Ltd.
Victory Way | Crossways | Dartford DA2 6QD |
United Kingdom | Tel +66 2 733 9140 | Fax +66 2 733 9153 |
sales.uk@ligman.com

Technical amendments reserved.

Nybro 5 Tunable White

Surface ceiling Down light

Project :	Location :	Type :	Quantity :
Note :			

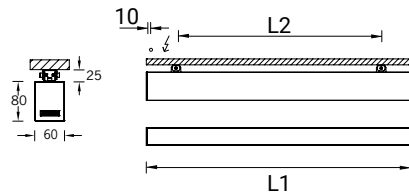
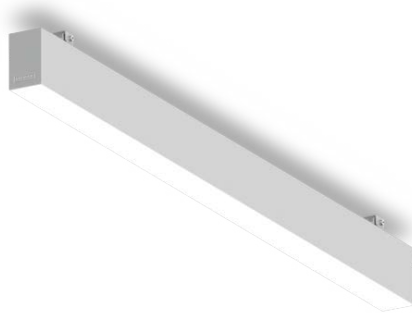

Luminaire Structure

Pendant, surface and suspended interior lighting system Powerful, flexible continuous illumination with a myriad of light source and control options

Light Symbol



Down light

Ordering guide sample

NYB-80625 - O - TUV - A81581
 Diffuser Colour Accessory

Diffuser for light output control
 O - Opal diffuser UGR <19
 P - Micro-prismatic UGR <13

Colour Temperature
 TUV - Tunable white
 2700K - 6500K

Optional diffuser

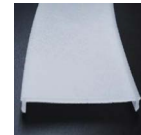

(- O)
Opal diffuser
UGR <19

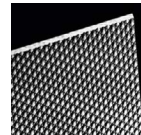

(- P)
Micro-prismatic diffuser
UGR <13

Product Code

Model No.	No. LED		System Power W	Lumen lm	Colour	EEC	Dimension		Weight kg
	Up	Down					L1	L2	
SURFACE CEILING MOUNTED · DOWN LIGHT · 60x80MM. · TUNABLE WHITE · OPAL DIFFUSER									
NYB-80625 - O - TUV	-	144 LED	37	2390	TUV	A++	1178	972	3.64
NYB-80645 - O - TUV	-	216 LED	55	4480	TUV	A++	1754	1548	5.61
NYB-80655 - O - TUV	-	288 LED	74	6323	TUV	A++	2330	2124	7.11
NYB-80665 - O - TUV	-	360 LED	92	8760	TUV	A++	2906	2700	8.60
SURFACE CEILING MOUNTED · DOWN LIGHT · 60x80MM. · TUNABLE WHITE · MICRO-PRISMATIC DIFFUSER									
NYB-80625 - P - TUV	-	144 LED	37	2037	TUV	A++	1178	972	3.64
NYB-80645 - P - TUV	-	216 LED	55	3819	TUV	A++	1754	1548	5.61
NYB-80655 - P - TUV	-	288 LED	74	5390	TUV	A++	2330	2124	7.11
NYB-80665 - P - TUV	-	360 LED	92	7468	TUV	A++	2906	2700	8.60

Accessory For Wireless Bluetooth

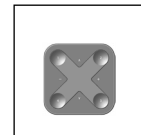

xPress Wireless switch (A90591)



Wireless Bluetooth (A90291)

Accessory

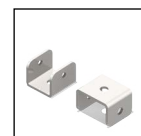

Bracket For Ceilings (A81281)



Continuous coupler bracket (A81581)

Colour Code

- 01	- 03	- 05	
Black RAL 9011	White RAL 9003	Matt Silver RAL 9006	RESET

HEADQUARTERS EUROPE

Ligman Europe s.r.o.
VGP Park Ústí nad Labem, P2 | Přestanov 120 | 40317 Přestanov | Czech Republic | Tel. +420 477 07 1500 | sales.cz@ligman.com
www.ligman.com

HEADQUARTERS THAILAND

Ligman Lighting Co., Ltd.
17/2 | Moo 4 | Monthong | Bangnampreaw | Chachoengsao 24150 | Thailand | Tel : +66 (2) 7339140 | info@ligman.com

Ligman Ltd.
Victory Way | Crossways | Dartford DA2 6QD | United Kingdom | Tel +66 2 733 9140 | Fax +66 2 733 9153 | sales.uk@ligman.com

Technical amendments reserved.

Nybro 6 Dimming Type

Surface ceiling Up-Down light

Project :	Location :	Type :	Quantity :
Note :			

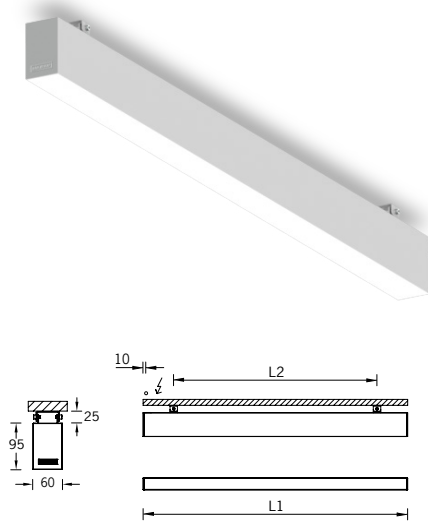

Luminaire Structure

Pendant, surface and suspended interior lighting system Powerful, flexible continuous illumination with a myriad of light source and control options

Light Symbol



Up - Down light

Ordering guide sample

NYB-80701 - O - W30 - DA - A81581
 Diffuser Colour Dim Type Accessory

Diffuser for light output control
 O - Opal diffuser UGR <19
 P - Micro-prismatic UGR <13

Dimming Type
 ND - Non dimmable
 DI - 1-10V dimmable
 DA - DALI dimmable

Colour Temperature
 W27 - Warm 2700K
 W30 - Warm white 3000K
 W40 - Neutral white 4000K
 W50 - Cool white 5000K

Product Code

Model No.	No. LED		System Power W	Lumen lm	Colour	EEC	Dimension		Weight kg
	Up	Down					L1	L2	

SURFACE CEILING MOUNTED · UP-DOWN LIGHT · 60x95MM. · DIMMING TYPE · OPAL DIFFUSER

NYB-80701 - O - W27	60 LED	72 LED	28	2873	2700K	A++	602	400	3.12
NYB-80701 - O - W30	60 LED	72 LED	28	3005	3000K	A++	602	400	3.12
NYB-80701 - O - W40	60 LED	72 LED	28	3137	4000K	A++	602	400	3.12
NYB-80701 - O - W50	60 LED	72 LED	28	3267	5000K	A++	602	400	3.12
NYB-80702 - O - W27	60 LED	72 LED	39	4104	2700K	A++	602	400	3.12
NYB-80702 - O - W30	60 LED	72 LED	39	4292	3000K	A++	602	400	3.12
NYB-80702 - O - W40	60 LED	72 LED	39	4480	4000K	A++	602	400	3.12
NYB-80702 - O - W50	60 LED	72 LED	39	4666	5000K	A++	602	400	3.12
NYB-80711 - O - W27	96 LED	108 LED	39	4453	2700K	A++	890	700	4.00
NYB-80711 - O - W30	96 LED	108 LED	39	4657	3000K	A++	890	700	4.00
NYB-80711 - O - W40	96 LED	108 LED	39	4861	4000K	A++	890	700	4.00
NYB-80711 - O - W50	96 LED	108 LED	39	5063	5000K	A++	890	700	4.00
NYB-80712 - O - W27	96 LED	108 LED	55	6156	2700K	A++	890	700	4.00
NYB-80712 - O - W30	96 LED	108 LED	55	6439	3000K	A++	890	700	4.00
NYB-80712 - O - W40	96 LED	108 LED	55	6721	4000K	A++	890	700	4.00
NYB-80712 - O - W50	96 LED	108 LED	55	7001	5000K	A++	890	700	4.00

Optional diffuser

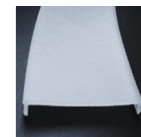

(- O)
Opal diffuser
UGR <19

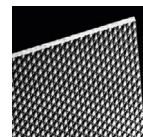

(- P)
Micro-prismatic diffuser
UGR <13

Dimming Type

ND DI DA

Colour Code

- 01	- 03	- 05	RESET
Black RAL 9011	White RAL 9003	Matt Silver RAL 9006	

HEADQUARTERS EUROPE

Ligman Europe s.r.o.
VGP Park Usti nad Labem, P2 | Přestanov 120 | 40317 Přestanov |
Czech Republic | Tel. +420 477 07 1500 | sales.cz@ligman.com
www.ligman.com

HEADQUARTERS THAILAND

Ligman Lighting Co., Ltd.
17/2 | Moo 4 | Monthong | Bangnampreaw | Chachoengsao 24150 |
Thailand | Tel : +66 (2) 7339140 | info@ligman.com

Ligman Ltd.
Victory Way | Crossways | Dartford DA2 6QD |
United Kingdom | Tel +66 2 733 9140 | Fax +66 2 733 9153 |
sales.uk@ligman.com

Technical amendments reserved.

Nybro 6 Dimming Type

Surface ceiling Up-Down light

Project :	Location :	Type :	Quantity :
Note :			

Product Code

Model No.	No. LED		System Power W	Lumen lm	Colour	EEC	Dimension		Weight kg
	Up	Down					L1	L2	

SURFACE CEILING MOUNTED · UP-DOWN LIGHT · 60x95MM. · DIMMING TYPE · OPAL DIFFUSER

NYB-80721 - O - W27	132 LED	144 LED	50	5938	2700K	A++	1178	980	4.89
NYB-80721 - O - W30	132 LED	144 LED	50	6210	3000K	A++	1178	980	4.89
NYB-80721 - O - W40	132 LED	144 LED	50	6482	4000K	A++	1178	980	4.89
NYB-80721 - O - W50	132 LED	144 LED	50	6752	5000K	A++	1178	980	4.89
NYB-80722 - O - W27	132 LED	144 LED	74	8207	2700K	A++	1178	980	4.89
NYB-80722 - O - W30	132 LED	144 LED	74	8584	3000K	A++	1178	980	4.89
NYB-80722 - O - W40	132 LED	144 LED	74	8960	4000K	A++	1178	980	4.89
NYB-80722 - O - W50	132 LED	144 LED	74	9333	5000K	A++	1178	980	4.89
NYB-80731 - O - W27	168 LED	180 LED	63	7421	2700K	A++	1466	1265	5.81
NYB-80731 - O - W30	168 LED	180 LED	63	7762	3000K	A++	1466	1265	5.81
NYB-80731 - O - W40	168 LED	180 LED	63	8102	4000K	A++	1466	1265	5.81
NYB-80731 - O - W50	168 LED	180 LED	63	8439	5000K	A++	1466	1265	5.81
NYB-80732 - O - W27	168 LED	180 LED	92	10259	2700K	A++	1466	1265	5.81
NYB-80732 - O - W30	168 LED	180 LED	92	10730	3000K	A++	1466	1265	5.81
NYB-80732 - O - W40	168 LED	180 LED	92	11200	4000K	A++	1466	1265	5.81
NYB-80732 - O - W50	168 LED	180 LED	92	11666	5000K	A++	1466	1265	5.81
NYB-80741 - O - W27	204 LED	216 LED	75	8906	2700K	A++	1754	1555	6.60
NYB-80741 - O - W30	204 LED	216 LED	75	9315	3000K	A++	1754	1555	6.60
NYB-80741 - O - W40	204 LED	216 LED	75	9723	4000K	A++	1754	1555	6.60
NYB-80741 - O - W50	204 LED	216 LED	75	10127	5000K	A++	1754	1555	6.60
NYB-80742 - O - W27	204 LED	216 LED	100	12312	2700K	A++	1754	1555	6.60
NYB-80742 - O - W30	204 LED	216 LED	100	12876	3000K	A++	1754	1555	6.60
NYB-80742 - O - W40	204 LED	216 LED	100	13441	4000K	A++	1754	1555	6.60
NYB-80742 - O - W50	204 LED	216 LED	100	14000	5000K	A++	1754	1555	6.60
NYB-80751 - O - W27	276 LED	288 LED	110	11875	2700K	A++	2330	2130	8.50
NYB-80751 - O - W30	276 LED	288 LED	110	12420	3000K	A++	2330	2130	8.50
NYB-80751 - O - W40	276 LED	288 LED	110	12964	4000K	A++	2330	2130	8.50
NYB-80751 - O - W50	276 LED	288 LED	110	13503	5000K	A++	2330	2130	8.50
NYB-80752 - O - W27	276 LED	288 LED	148	16416	2700K	A++	2330	2130	8.50
NYB-80752 - O - W30	276 LED	288 LED	148	17168	3000K	A++	2330	2130	8.50
NYB-80752 - O - W40	276 LED	288 LED	148	17921	4000K	A++	2330	2130	8.50
NYB-80752 - O - W50	276 LED	288 LED	148	18667	5000K	A++	2330	2130	8.50
NYB-80761 - O - W27	348 LED	360 LED	124	14844	2700K	A++	2906	2705	10.28
NYB-80761 - O - W30	348 LED	360 LED	124	15524	3000K	A++	2906	2705	10.28
NYB-80761 - O - W40	348 LED	360 LED	124	16205	4000K	A++	2906	2705	10.28
NYB-80761 - O - W50	348 LED	360 LED	124	16879	5000K	A++	2906	2705	10.28
NYB-80762 - O - W27	348 LED	360 LED	184	20519	2700K	A++	2906	2705	10.28
NYB-80762 - O - W30	348 LED	360 LED	184	21460	3000K	A++	2906	2705	10.28
NYB-80762 - O - W40	348 LED	360 LED	184	22401	4000K	A++	2906	2705	10.28
NYB-80762 - O - W50	348 LED	360 LED	184	23333	5000K	A++	2906	2705	10.28

Accessory For Wireless Bluetooth

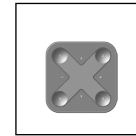

xPress Wireless switch (A90591)



Wireless Bluetooth (A90291)

Accessory



Continuous coupler bracket (A81581)

* Installation manual available online at www.ligman.com.
 * Luminous flux and system power are rated from absolute photometry according to LM-79-08 standard for LED luminaire.
 * Photometric diagram for standard non-accessory, please consult the factory in case accessory option.

HEADQUARTERS EUROPE

Ligman Europe s.r.o.
 VGP Park Ústí nad Labem, P2 | Přestanov 120 | 40317 Přestanov |
 Czech Republic | Tel. +420 477 07 1500 | sales.cz@ligman.com
www.ligman.com

HEADQUARTERS THAILAND

Ligman Lighting Co.,Ltd.
 17/2 | Moo 4 | Monthong | Bangnampreaw | Chachoengsao 24150 |
 Thailand | Tel : +66 (2) 7339140 | info@ligman.com

Ligman Ltd.
 Victory Way | Crossways | Dartford DA2 6QD |
 United Kingdom | Tel +66 2 733 9140 | Fax +66 2 733 9153 |
sales.uk@ligman.com

Technical amendments reserved.

Nybro 6 Dimming Type

Surface ceiling Up-Down light

Project :	Location :	Type :	Quantity :
Note :			

Product Code

Model No.	No. LED		System Power W	Lumen lm	Colour	EEC	Dimension		Weight kg
	Up	Down					L1	L2	

SURFACE CEILING MOUNTED · UP-DOWN LIGHT · 60x95MM. · DIMMING TYPE · MICRO-PRISMATIC DIFFUSER

NYB-80701 - P - W27	60 LED	72 LED	28	2450	2700K	A++	602	400	3.12
NYB-80701 - P - W30	60 LED	72 LED	28	2562	3000K	A++	602	400	3.12
NYB-80701 - P - W40	60 LED	72 LED	28	2674	4000K	A++	602	400	3.12
NYB-80701 - P - W50	60 LED	72 LED	28	2786	5000K	A++	602	400	3.12
NYB-80702 - P - W27	60 LED	72 LED	39	3498	2700K	A++	602	400	3.12
NYB-80702 - P - W30	60 LED	72 LED	39	3659	3000K	A++	602	400	3.12
NYB-80702 - P - W40	60 LED	72 LED	39	3819	4000K	A++	602	400	3.12
NYB-80702 - P - W50	60 LED	72 LED	39	3978	5000K	A++	602	400	3.12
NYB-80711 - P - W27	96 LED	108 LED	39	3796	2700K	A++	890	700	4.00
NYB-80711 - P - W30	96 LED	108 LED	39	3970	3000K	A++	890	700	4.00
NYB-80711 - P - W40	96 LED	108 LED	39	4144	4000K	A++	890	700	4.00
NYB-80711 - P - W50	96 LED	108 LED	39	4316	5000K	A++	890	700	4.00
NYB-80712 - P - W27	96 LED	108 LED	55	5248	2700K	A++	890	700	4.00
NYB-80712 - P - W30	96 LED	108 LED	55	5489	3000K	A++	890	700	4.00
NYB-80712 - P - W40	96 LED	108 LED	55	5730	4000K	A++	890	700	4.00
NYB-80712 - P - W50	96 LED	108 LED	55	5968	5000K	A++	890	700	4.00
NYB-80721 - P - W27	132 LED	144 LED	50	5062	2700K	A++	1178	980	4.89
NYB-80721 - P - W30	132 LED	144 LED	50	5294	3000K	A++	1178	980	4.89
NYB-80721 - P - W40	132 LED	144 LED	50	5526	4000K	A++	1178	980	4.89
NYB-80721 - P - W50	132 LED	144 LED	50	5756	5000K	A++	1178	980	4.89
NYB-80722 - P - W27	132 LED	144 LED	74	6997	2700K	A++	1178	980	4.89
NYB-80722 - P - W30	132 LED	144 LED	74	7318	3000K	A++	1178	980	4.89
NYB-80722 - P - W40	132 LED	144 LED	74	7638	4000K	A++	1178	980	4.89
NYB-80722 - P - W50	132 LED	144 LED	74	7956	5000K	A++	1178	980	4.89
NYB-80731 - P - W27	168 LED	180 LED	63	6327	2700K	A++	1466	1210	5.79
NYB-80731 - P - W30	168 LED	180 LED	63	6617	3000K	A++	1466	1210	5.79
NYB-80731 - P - W40	168 LED	180 LED	63	6907	4000K	A++	1466	1210	5.79
NYB-80731 - P - W50	168 LED	180 LED	63	7194	5000K	A++	1466	1210	5.79
NYB-80732 - P - W27	168 LED	180 LED	92	8746	2700K	A++	1466	1210	5.79
NYB-80732 - P - W30	168 LED	180 LED	92	9147	3000K	A++	1466	1210	5.79
NYB-80732 - P - W40	168 LED	180 LED	92	9548	4000K	A++	1466	1210	5.79
NYB-80732 - P - W50	168 LED	180 LED	92	9945	5000K	A++	1466	1210	5.79
NYB-80741 - P - W27	204 LED	216 LED	75	7593	2700K	A++	1754	1498	6.07
NYB-80741 - P - W30	204 LED	216 LED	75	7941	3000K	A++	1754	1498	6.07
NYB-80741 - P - W40	204 LED	216 LED	75	8289	4000K	A++	1754	1498	6.07
NYB-80741 - P - W50	204 LED	216 LED	75	8634	5000K	A++	1754	1498	6.07
NYB-80742 - P - W27	204 LED	216 LED	100	10496	2700K	A++	1754	1498	6.07
NYB-80742 - P - W30	204 LED	216 LED	100	10977	3000K	A++	1754	1498	6.07
NYB-80742 - P - W40	204 LED	216 LED	100	11458	4000K	A++	1754	1498	6.07
NYB-80742 - P - W50	204 LED	216 LED	100	11935	5000K	A++	1754	1498	6.07
NYB-80751 - P - W27	276 LED	288 LED	110	10123	2700K	A++	2330	2130	8.50
NYB-80751 - P - W30	276 LED	288 LED	110	10588	3000K	A++	2330	2130	8.50
NYB-80751 - P - W40	276 LED	288 LED	110	11052	4000K	A++	2330	2130	8.50
NYB-80751 - P - W50	276 LED	288 LED	110	11512	5000K	A++	2330	2130	8.50
NYB-80752 - P - W27	276 LED	288 LED	148	13994	2700K	A++	2330	2130	8.50
NYB-80752 - P - W30	276 LED	288 LED	148	14636	3000K	A++	2330	2130	8.50
NYB-80752 - P - W40	276 LED	288 LED	148	15278	4000K	A++	2330	2130	8.50
NYB-80752 - P - W50	276 LED	288 LED	148	15913	5000K	A++	2330	2130	8.50
NYB-80761 - P - W27	348 LED	360 LED	124	12654	2700K	A++	2906	2705	10.28
NYB-80761 - P - W30	348 LED	360 LED	124	13235	3000K	A++	2906	2705	10.28
NYB-80761 - P - W40	348 LED	360 LED	124	13815	4000K	A++	2906	2705	10.28
NYB-80761 - P - W50	348 LED	360 LED	124	14389	5000K	A++	2906	2705	10.28
NYB-80762 - P - W27	348 LED	360 LED	184	17493	2700K	A++	2906	2705	10.28
NYB-80762 - P - W30	348 LED	360 LED	184	18295	3000K	A++	2906	2705	10.28
NYB-80762 - P - W40	348 LED	360 LED	184	19097	4000K	A++	2906	2705	10.28
NYB-80762 - P - W50	348 LED	360 LED	184	19891	5000K	A++	2906	2705	10.28

HEADQUARTERS EUROPE

Ligman Europe s.r.o.
VGP Park Usti nad Labem, P2 | Přestanov 120 | 40317 Přestanov |
Czech Republic | Tel. +420 477 07 1500 | sales.cz@ligman.com
www.ligman.com

HEADQUARTERS THAILAND

Ligman Lighting Co., Ltd.
17/2 | Moo 4 | Monthong | Bangnampreaw | Chachoengsao 24150 |
Thailand | Tel: +66 (2) 7339140 | info@ligman.com

Ligman Ltd.
Victory Way | Crossways | Dartford DA2 6QD |
United Kingdom | Tel +66 2 733 9140 | Fax +66 2 733 9153 |
sales.uk@ligman.com

Technical amendments reserved.

Nybro 6 Dimming Type

Surface ceiling Up-Down light

Project :	Location :	Type :	Quantity :
Note :			

Photometric

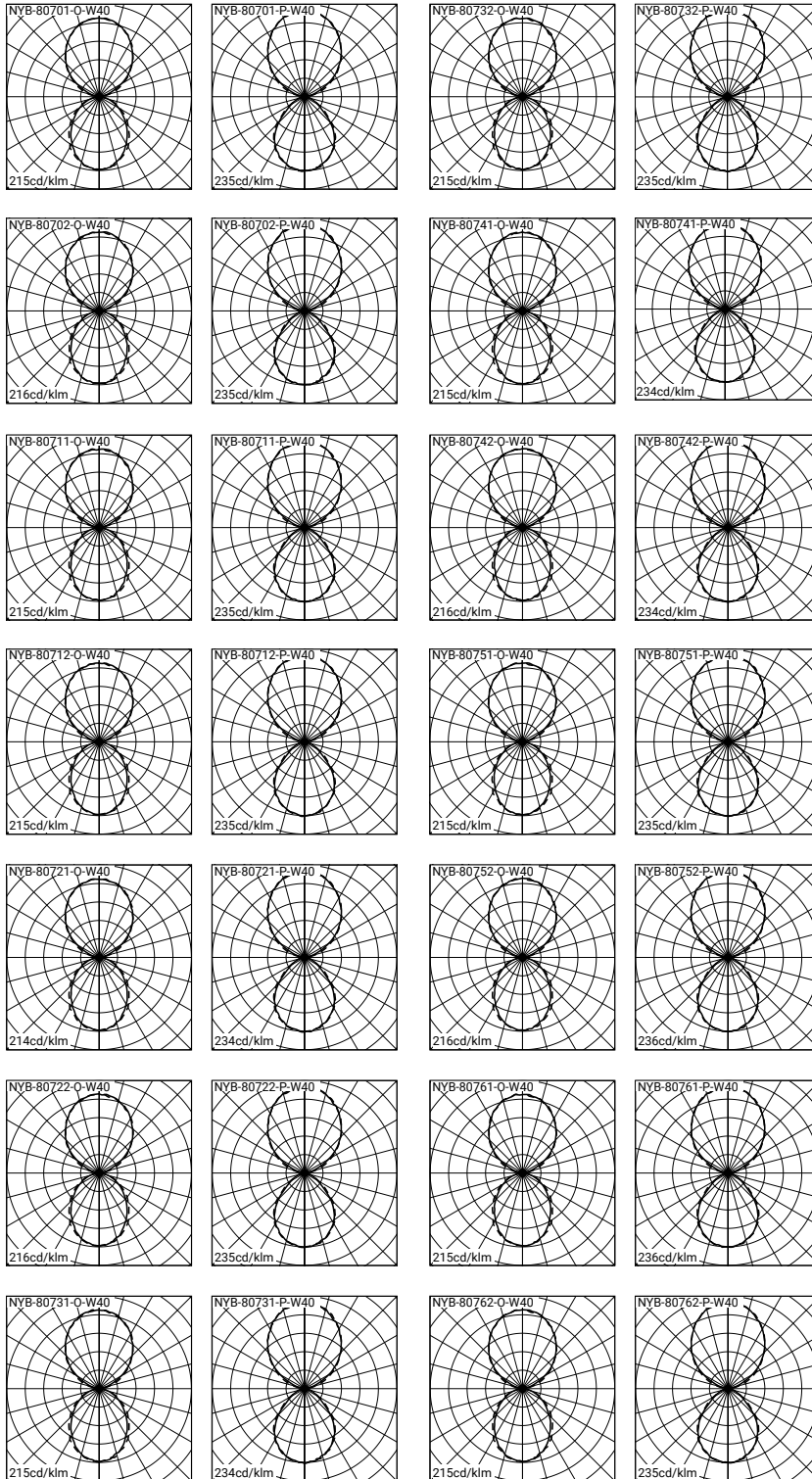

HEADQUARTERS EUROPE

Ligman Europe s.r.o.
VGP Park Usti nad Labem, P2 | Přestanov 120 | 40317 Přestanov |
Czech Republic | Tel. +420 477 07 1500 | sales.cz@ligman.com
www.ligman.com

HEADQUARTERS THAILAND

Ligman Lighting Co., Ltd.
17/2 | Moo 4 | Monthong | Bangnampreaw | Chachoengsao 24150 |
Thailand | Tel : +66 (2) 7339140 | info@ligman.com

Ligman Ltd.
Victory Way | Crossways | Dartford DA2 6QD |
United Kingdom | Tel +66 2 733 9140 | Fax +66 2 733 9153 |
sales.uk@ligman.com

Technical amendments reserved.

Nybro 6 Sensor Control

Surface ceiling Up-Down light

Project :	Location :	Type :	Quantity :
Note :			

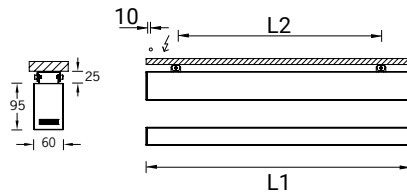
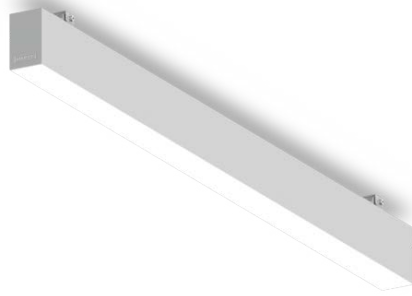

Luminaire Structure

Pendant, surface and suspended interior lighting system Powerful, flexible continuous illumination with a myriad of light source and control options

Light Symbol



Up - Down light

Ordering guide sample

NYB-80723 - O - W30 - WBT - A81581

Diffuser Colour Sensor Accessory

Diffuser for light output control
 O - Opal diffuser UGR <19
 P - Micro-prismatic UGR <13

Colour Temperature
 W27 - Warm 2700K
 W30 - Warm white 3000K
 W40 - Neutral white 4000K
 W50 - Cool white 5000K

Optional diffuser



(- O)
Opal diffuser
UGR <19

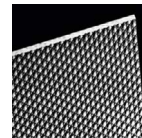

(- P)
Micro-prismatic diffuser
UGR <13

Product Code

Model No.	No. LED		System Power W	Lumen lm	Colour	EEC	Dimension		Weight kg
	Up	Down					L1	L2	

SURFACE CEILING MOUNTED · UP-DOWN LIGHT · 60x95MM · SENSOR CONTROL · OPAL DIFFUSER

NYB-80723	- O - W27	132 LED	132 LED	72	8024	2700K	A++	1178	980	5.14
NYB-80723	- O - W30	132 LED	132 LED	72	8392	3000K	A++	1178	980	5.14
NYB-80723	- O - W40	132 LED	132 LED	72	8760	4000K	A++	1178	980	5.14
NYB-80723	- O - W50	132 LED	132 LED	72	9124	5000K	A++	1178	980	5.14
NYB-80733	- O - W27	168 LED	168 LED	90	10076	2700K	A++	1466	1265	6.06
NYB-80733	- O - W30	168 LED	168 LED	90	10538	3000K	A++	1466	1265	6.06
NYB-80733	- O - W40	168 LED	168 LED	90	11000	4000K	A++	1466	1265	6.06
NYB-80733	- O - W50	168 LED	168 LED	90	11458	5000K	A++	1466	1265	6.06
NYB-80743	- O - W27	204 LED	204 LED	108	12130	2700K	A++	1754	1555	6.85
NYB-80743	- O - W30	204 LED	204 LED	108	12686	3000K	A++	1754	1555	6.85
NYB-80743	- O - W40	204 LED	204 LED	108	13242	4000K	A++	1754	1555	6.85
NYB-80743	- O - W50	204 LED	204 LED	108	13793	5000K	A++	1754	1555	6.85
NYB-80753	- O - W27	276 LED	276 LED	146	16232	2700K	A++	2330	2130	8.75
NYB-80753	- O - W30	276 LED	276 LED	146	16977	3000K	A++	2330	2130	8.75
NYB-80753	- O - W40	276 LED	276 LED	146	17721	4000K	A++	2330	2130	8.75
NYB-80753	- O - W50	276 LED	276 LED	146	18458	5000K	A++	2330	2130	8.75
NYB-80763	- O - W27	348 LED	348 LED	182	20336	2700K	A++	2906	2705	10.28
NYB-80763	- O - W30	348 LED	348 LED	182	21269	3000K	A++	2906	2705	10.28
NYB-80763	- O - W40	348 LED	348 LED	182	22201	4000K	A++	2906	2705	10.28
NYB-80763	- O - W50	348 LED	348 LED	182	23125	5000K	A++	2906	2705	10.28

Accessory



Continuous coupler bracket (A81581)

Colour Code

- 01	- 03	- 05	
Black RAL 9011	White RAL 9003	Matt Silver RAL 9006	RESET

HEADQUARTERS EUROPE

Ligman Europe s.r.o.
 VGP Park Usti nad Labem, P2 | Přestanov 120 | 40317 Přestanov |
 Czech Republic | Tel. +420 477 07 1500 | sales.cz@ligman.com
 www.ligman.com

HEADQUARTERS THAILAND

Ligman Lighting Co., Ltd.
 17/2 | Moo 4 | Monthong | Bangnampreaw | Chachoengsao 24150 |
 Thailand | Tel : +66 (2) 7339140 | info@ligman.com

Ligman Ltd.
 Victory Way | Crossways | Dartford DA2 6QD |
 United Kingdom | Tel +66 2 733 9140 | Fax +66 2 733 9153 |
 sales.uk@ligman.com

Technical amendments reserved.

Nybro 6 Sensor Control

Surface ceiling Up-Down light

Project :	Location :	Type :	Quantity :
Note :			

Product Code

Model No.	No. LED		System Power W	Lumen lm	Colour	EEC	Dimension		Weight kg
	Up	Down					L1	L2	
SURFACE CEILING MOUNTED · UP-DOWN LIGHT · 60x95MM. · SENSOR CONTROL · MICRO-PRISMATIC DIFFUSER									
NYB-80723 - P - W27	132 LED	132 LED	72	6841	2700K	A++	1178	980	5.14
NYB-80723 - P - W30	132 LED	132 LED	72	7154	3000K	A++	1178	980	5.14
NYB-80723 - P - W40	132 LED	132 LED	72	7468	4000K	A++	1178	980	5.14
NYB-80723 - P - W50	132 LED	132 LED	72	7779	5000K	A++	1178	980	5.14
NYB-80733 - P - W27	168 LED	168 LED	90	8590	2700K	A++	1466	1265	6.06
NYB-80733 - P - W30	168 LED	168 LED	90	8984	3000K	A++	1466	1265	6.06
NYB-80733 - P - W40	168 LED	168 LED	90	9378	4000K	A++	1466	1265	6.06
NYB-80733 - P - W50	168 LED	168 LED	90	9768	5000K	A++	1466	1265	6.06
NYB-80743 - P - W27	204 LED	204 LED	108	10341	2700K	A++	1754	1555	6.85
NYB-80743 - P - W30	204 LED	204 LED	108	10815	3000K	A++	1754	1555	6.85
NYB-80743 - P - W40	204 LED	204 LED	108	11289	4000K	A++	1754	1555	6.85
NYB-80743 - P - W50	204 LED	204 LED	108	11759	5000K	A++	1754	1555	6.85
NYB-80753 - P - W27	276 LED	276 LED	146	13838	2700K	A++	2330	2130	8.75
NYB-80753 - P - W30	276 LED	276 LED	146	14473	3000K	A++	2330	2130	8.75
NYB-80753 - P - W40	276 LED	276 LED	146	15107	4000K	A++	2330	2130	8.75
NYB-80753 - P - W50	276 LED	276 LED	146	15735	5000K	A++	2330	2130	8.75
NYB-80763 - P - W27	348 LED	348 LED	182	17336	2700K	A++	2906	2705	10.28
NYB-80763 - P - W30	348 LED	348 LED	182	18131	3000K	A++	2906	2705	10.28
NYB-80763 - P - W40	348 LED	348 LED	182	18926	4000K	A++	2906	2705	10.28
NYB-80763 - P - W50	348 LED	348 LED	182	19713	5000K	A++	2906	2705	10.28

* Installation manual available online at www.ligman.com.

* Luminous flux and system power are rated from absolute photometry according to LM-79-08 standard for LED luminaire.
* Photometric diagram for standard non-accessory, please consult the factory in case accessory option.

HEADQUARTERS EUROPE

Ligman Europe s.r.o.
VGP Park Ústí nad Labem, P2 | Přestanov 120 | 40317 Přestanov |
Czech Republic | Tel. +420 477 07 1500 | sales.cz@ligman.com
www.ligman.com

HEADQUARTERS THAILAND

Ligman Lighting Co.,Ltd.
17/2 | Moo 4 | Monthong | Bangnampreaw | Chachoengsao 24150 |
Thailand | Tel : +66 (2) 7339140 | info@ligman.com

Ligman Ltd.
Victory Way | Crossways | Dartford DA2 6QD |
United Kingdom | Tel +66 2 733 9140 | Fax +66 2 733 9153 |
sales.uk@ligman.com

Technical amendments reserved.

Nybro 5 Tunable White

Surface ceiling Up-Down light

Project :	Location :	Type :	Quantity :
Note :			

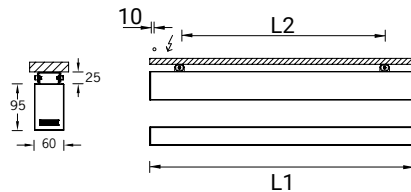
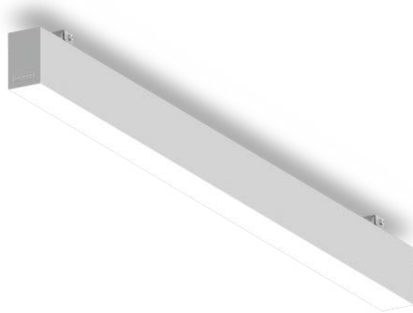

Luminaire Structure

Pendant, surface and suspended interior lighting system Powerful, flexible continuous illumination with a myriad of light source and control options

Light Symbol



Up - Down light

Ordering guide sample

NYB-80724 - O - TUV - A81581

Diffuser: O (Opal), Colour: TUV (Tunable white), Accessory: A81581

Diffuser for light output control
 O - Opal diffuser UGR <19
 P - Micro-prismatic UGR <13

Colour Temperature
 TUV - Tunable white
 2700K - 6500K

Optional diffuser

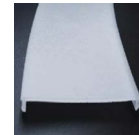

(- O)
Opal diffuser
UGR <19

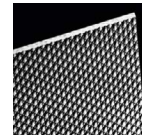

(- P)
Micro-prismatic diffuser
UGR <13

Product Code

Model No.	No. LED		System Power W	Lumen lm	Colour	EEC	Dimension		Weight kg
	Up	Down					L1	L2	

SURFACE CEILING MOUNTED · UP-DOWN LIGHT · 60x95MM · TUNABLE WHITE · OPAL DIFFUSER

NYB-80724 - O - TUV	132 LED	144 LED	50	6482	TUV	A++	1178	980	4.89
NYB-80754 - O - TUV	276 LED	288 LED	108	13242	TUV	A++	2330	2130	9.50
NYB-80764 - O - TUV	348 LED	360 LED	136	16205	TUV	A++	2906	2705	11.28

SURFACE CEILING MOUNTED · UP-DOWN LIGHT · 60x95MM · TUNABLE WHITE · MICRO-PRISMATIC DIFFUSER

NYB-80724 - P - TUV	132 LED	144 LED	74	5526	TUV	A++	1178	980	4.89
NYB-80754 - P - TUV	276 LED	288 LED	124	11289	TUV	A++	2330	2130	9.50
NYB-80764 - P - TUV	348 LED	360 LED	184	13815	TUV	A++	2906	2705	11.28

Accessory For Wireless Bluetooth

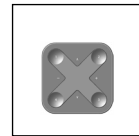

xPress Wireless switch (A90591)



Wireless Bluetooth (A90291)

Accessory



Continuous coupler bracket (A81581)

Colour Code

- 01	- 03	- 05	
Black RAL 9011	White RAL 9003	Matt Silver RAL 9006	RESET

HEADQUARTERS EUROPE

Ligman Europe s.r.o.
 VGP Park Usti nad Labem, P2 | Přestanov 120 | 40317 Přestanov |
 Czech Republic | Tel. +420 477 07 1500 | sales.cz@ligman.com
 www.ligman.com

HEADQUARTERS THAILAND

Ligman Lighting Co., Ltd.
 17/2 | Moo 4 | Monthong | Bangnampreaw | Chachoengsao 24150 |
 Thailand | Tel : +66 (2) 7339140 | info@ligman.com

Ligman Ltd.
 Victory Way | Crossways | Dartford DA2 6QD |
 United Kingdom | Tel +66 2 733 9140 | Fax +66 2 733 9153 |
 sales.uk@ligman.com

Technical amendments reserved.